



intel®



Intel®  
FPGA  
Product  
Catalog

The background of the cover features a night-time cityscape with illuminated skyscrapers. A network of white lines connects various points across the image, with several circular icons overlaid: a Wi-Fi symbol on the left, a location pin on the right, and an envelope icon near the bottom right. The overall color palette is dominated by deep blues and purples, with the city lights providing a warm contrast.

Version 23.1

# Contents

## Overview

- Intel® FPGA and Custom Logic Solutions Portfolio 1

## Devices

- Intel Agilex® FPGA Portfolio
  - Intel Agilex FPGAs and SoCs 2
  - Intel Agilex 7 FPGA and SoC Overview 3
  - Intel Agilex 7 FPGA and SoC F-Series Features 5
  - Intel Agilex 7 FPGA and SoC I-Series Features 7
  - Intel Agilex 7 FPGA and SoC M-Series Features 9
  - Intel Agilex 5 FPGA and SoC Overview 11
  - Intel Agilex 5 FPGA and SoC E-Series Features 13
  - Intel Agilex 5 FPGA and SoC D-Series Features 15
- Generation 10 Device Portfolio
  - Generation 10 FPGAs and SoCs 16
  - Intel® Stratix® 10 FPGA and SoC Overview 17
  - Intel Stratix 10 GX FPGA Features 19
  - Intel Stratix 10 TX FPGA Features 21
  - Intel Stratix 10 MX FPGA Features 23
  - Intel Stratix 10 DX FPGA Features 25
  - Intel Stratix 10 SX SoC Features 27
  - Intel® Arria® 10 FPGA and SoC Overview 30
  - Intel Arria 10 FPGA Features 31
  - Intel Arria 10 SoC Features 33
  - Intel® Cyclone® 10 FPGA Overview 35
  - Intel Cyclone 10 GX FPGA Features 36
  - Intel Cyclone 10 LP FPGA Features 37
  - Intel® MAX® 10 FPGA Overview 39
  - Intel MAX 10 FPGA Features 40
- Structured ASICs
  - Intel® eASIC™ Device Overview 41
  - Intel eASIC N5X Device Features 42
  - Intel eASIC N3XS Device Features 43
  - Intel eASIC N3X Device Features 44
- 28 nm Device Portfolio
  - Arria V FPGA and SoC Features 45
  - Cyclone V FPGA Features 47
  - Cyclone V SoC Features 49
- 60 nm Device Portfolio
  - Cyclone IV FPGA Features 51
- MAX CPLD Series
  - MAX V CPLD Features 53
- Ordering Codes 55

## Acceleration Platform and Card Solutions

- Intel FPGA Acceleration Card Solutions 63
- Intel® Open FPGA Stack 66
- Intel FPGA IPU F2000X-PL 67
- Intel FPGA IPU C5000X-PL 68
- Intel FPGA SmartNIC N6000-PL Platform 69
- Accelerated Workload Solutions 71
- Intel FPGA Acceleration Card Comparison 72

## Design Tools, OS Support, and Processors

- Intel® Quartus® Prime Design Software 73
- DSP Builder for Intel® FPGAs 76
- Intel® FPGA SDK for OpenCL™ 77
- Embedded Software and Tools for Intel® SoC FPGA 78
- SoC FPGA Operating System Support 79
- Nios® V Processor 80
- RiscFree\* IDE for Intel® FPGAs 81
- Nios® II Processor 82
- Nios II Processor Embedded Design Suite 83
- Nios II Processor Operating System Support 84
- Customizable Processor Portfolio Overview 85

## Intellectual Property

- Intel and Intel Partner Alliance IP Functions 86
- Design Store 88

## Development Kits

- Intel FPGA and Partner Development Kits 89
- Intel FPGA-Based SoM Partner Ecosystem 94

## Partner Program

- Intel Partner Alliance Program 96

## Training

- Training Overview 97
- Instructor-Led and Virtual Classes 97

# Intel FPGA and Custom Logic Solutions Portfolio

Intel delivers a broad portfolio of custom logic solutions — FPGAs, SoCs, structured ASICs, and CPLDs—together with software tools, intellectual property (IP), embedded processors, customer support, and technical training. Intel's product leadership, excellent value, and superior quality of service give you a measurable advantage. Bring your great ideas to life faster, better, and more cost effectively.

## FPGAs, Structured ASICs, and CPLDs

Intel FPGAs and CPLDs give you the flexibility to innovate, differentiate, and stay ahead in the market. We have five classes of FPGAs to meet your market needs, from the industry's highest density and performance to the most cost effective.



### Intel Agilex FPGAs

The Intel Agilex portfolio presents a broad range of product offerings that address the full breadth of programmable logic needs across every technology sector from edge and embedded, to communications and data centers.



### Intel Cyclone Series

The Intel Cyclone FPGA series is built to meet your low-power, cost-sensitive design needs, enabling you to get to market faster.



### Intel Stratix Series

The Intel Stratix FPGA and SoC family enables you to deliver high-performance, state-of-the-art products to market faster with lower risk and higher productivity.



### Intel MAX Series

The Intel MAX 10 FPGAs revolutionize non-volatile integration by delivering advanced processing capabilities in a low-cost, single-chip small form.



### Intel Arria Series

The Intel Arria device family delivers performance and power efficiency in the midrange.



### Intel eASIC Devices

Intel eASIC structured ASIC devices complete the gap between FPGA and ASIC by delivering lower power and lower unit price versus FPGAs and lower non-recurring engineering (NRE) and faster time to market versus standard cell ASICs.

## Acceleration Platform or Card Solutions

Intel FPGA-based acceleration platforms or cards enable a scalable volume deployment of various workloads in edge, network, cloud, enterprise, and other types of data center environment through Intel FPGA Programmable Acceleration Cards (Intel FPGA PACs) and development software, such as the Intel Acceleration Stack for Intel Xeon CPU with FPGAs and the OpenVINO™ toolkit.

## Productivity-Enhancing Design Software, Embedded Processing, IP, Development Kits, and Training

With Intel, you get a complete design environment and a wide choice of design tools—all built to work together so your designs are up and running fast. You can try one of our training classes to get a jump-start on your designs. Choose Intel and see how we enhance your productivity and make a difference to your bottom line.



# Intel Agilex FPGAs and SoCs:

## A Comprehensive Programmable Logic Portfolio for the Connected World

[intel.com/agilex](https://intel.com/agilex)



The Intel Agilex portfolio presents a broad range of product offerings that address the full breadth of programmable logic needs across every technology sector from edge and embedded, to communications and data centers. In all these sectors, a data explosion is driving demand for new products to move, process, and store the data, as well as derive actionable insights from it. The developers of these products need hardware flexibility to address the challenges of changing market requirements, integrating multiple functions, adopting evolving standards, and supporting diverse workloads. Intel Agilex FPGAs provide the flexibility needed to tackle these challenges, as well as advanced application-optimized features and capabilities that help developers deliver innovation with agility.

### The Intel Agilex FPGA Product Portfolio

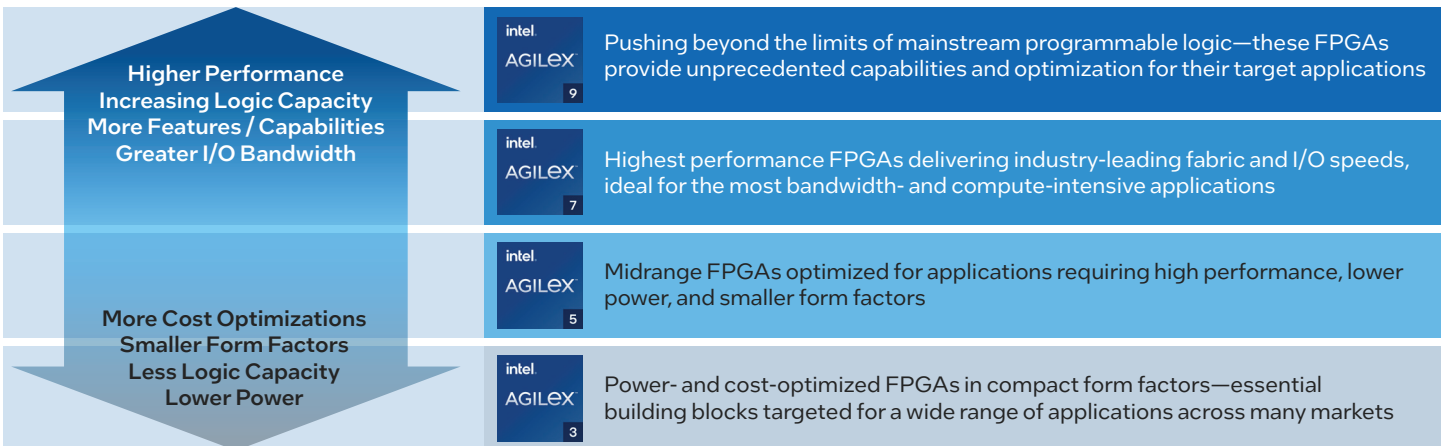

# Intel Agilex 7 FPGA and SoC Overview

## Intel Agilex 7 Devices



The Intel Agilex 7 devices include the industry's highest performance FPGAs providing a range of premium features for the most demanding applications, including the F-Series, I-Series, and M-Series. This tier offers the industry's highest data rate transceivers—up to 116 Gbps—the first PCIe 5.0 and CXL support, and options to integrate in-package HBM2E memory delivering the industry's highest memory bandwidth (over 1 TBps). These capabilities enable customized connectivity and acceleration for the most compute, bandwidth, and memory-intensive use cases in communications, data center, defense, high-performance computing, video, high-end test/measurement/medical, and more.

F-Series FPGAs and SoCs	I-Series FPGAs and SoCs	M-Series FPGAs and SoCs
<p>F-Series devices are general purpose FPGAs built on Intel 10 nm SuperFin process technology. With features including transceiver rates up to 58 Gbps, advanced digital signal processing (DSP) blocks supporting multiple precisions of fixed-point and floating-point operations, and high-performance crypto blocks, they are ideal for a wide range of applications across many markets.</p>	<p>I-Series devices offer the highest-performance I/O interfaces to address bandwidth-intensive applications. Manufactured on Intel 10 nm SuperFin process technology, this series builds upon the F-Series device features offering transceiver rates up to 116 Gbps, PCIe 5.0 support, and cache- and memory-coherent attach to processors with CXL.</p>	<p>M-Series devices are optimized for compute- and memory-intensive applications. Leveraging Intel 7 process technology, this series builds upon I-Series device features offering an extensive memory hierarchy including integrated high-bandwidth memory (HBM) and high-efficiency interfaces to DDR5 memory with a hard memory Network-on-Chip (NoC) to maximize memory bandwidth.</p>

## Efficient Network Transformation

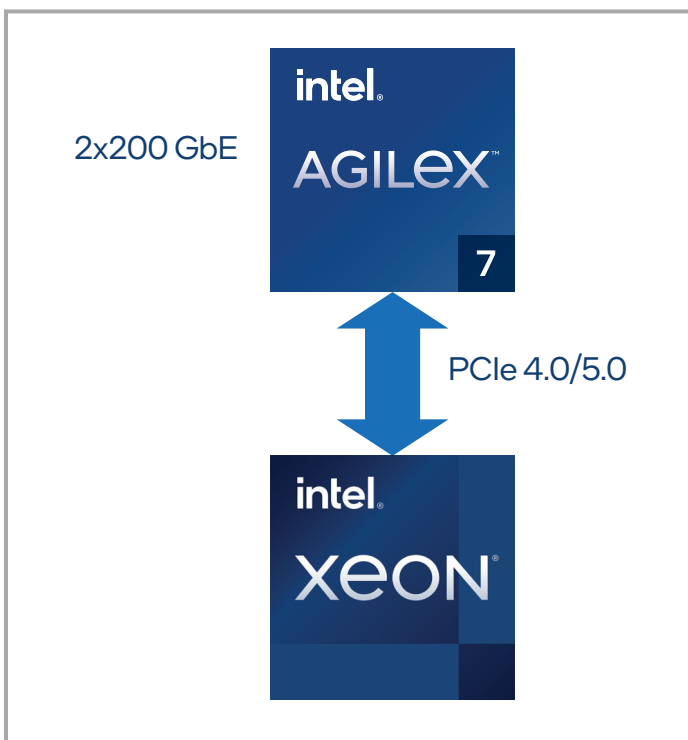

### Datapath Acceleration

#### VNF Performance Optimization

- Load balancing
- Data integrity
- Network translation

#### Significant Improvements

- Throughput
- Jitter
- Latency

### Infrastructure Offload

#### Optimized Architecture

- Infrastructure Processing Unit (IPU)
- vRouter
- Security

#### Small Form Factor and Low Power

- Wide range of servers

### Converged Workload Acceleration for the Data Center

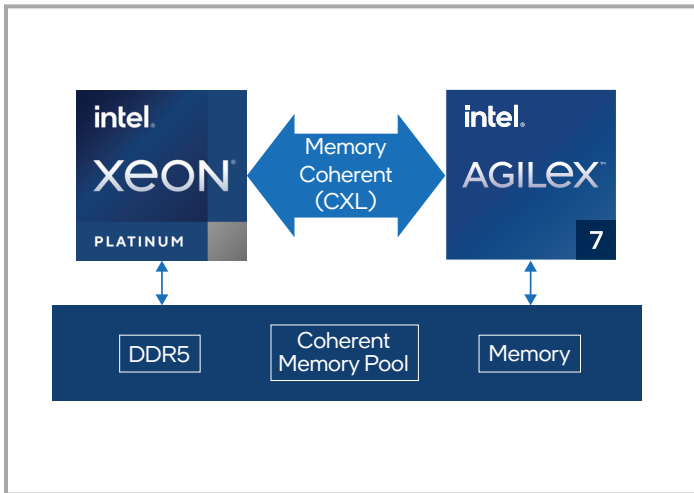

#### Infrastructure Acceleration

- Network
- Security
- Remote memory access

#### Application Acceleration

- Artificial intelligence (AI)
- Search
- Video transcode
- Database
- 38 TFLOPs of DSP performance<sup>1</sup>

#### Storage Acceleration

- Compression
- Decompression
- Encryption
- Memory hierarchy management

### Agility and Flexibility for All Stages of 5G Implementation

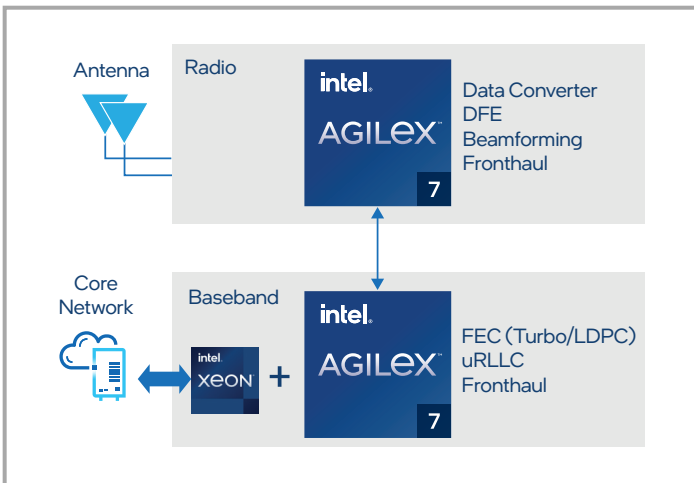

#### Custom Logic Continuum

##### FPGA Flexibility

- High flexibility
- Short time to market

##### Rapid Intel eASIC Device Optimization

- Power and cost optimization

##### Full Custom ASIC Optimization

- Best power<sup>1</sup>
- Best performance<sup>1</sup>
- Best cost<sup>1</sup>

##### Application-Specific Tile Options

- Data converter
- Vector engine
- Custom compute

### Smart, Safe, and Secure Factory Acceleration

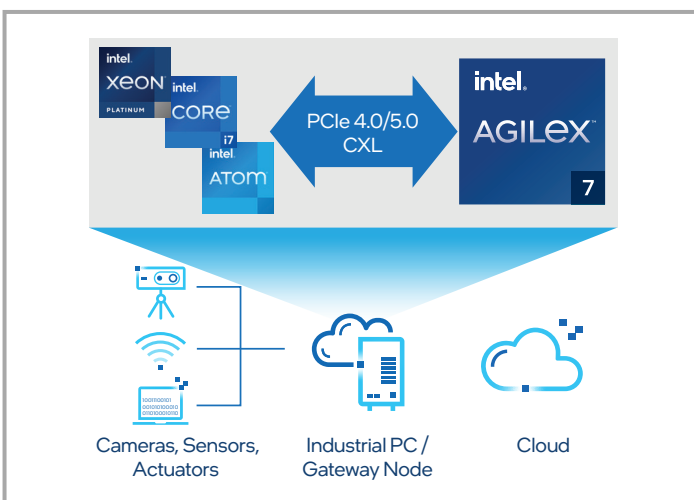

#### Acceleration and Analytics

- In-line protocol acceleration
- Look-aside application acceleration

#### Safety and Security

- Secure boot
- Encryption
- Authentication

#### Customized Connectivity

- Time-sensitive networks
- Flexible I/O

#### Product and Performance Information:

<sup>1</sup> This comparison is based on the Intel Agilex FPGA and SoC family vs. Intel Stratix 10 FPGA using simulation results and is subject to change. This document contains information on products, services and/or processes in development. All information provided here is subject to change without notice. Contact your Intel representative to obtain the latest forecast, schedule, specifications, and roadmaps.

Intel technologies' features and benefits depend on system configuration and may require enabled hardware, software or service activation. Learn more at [www.intel.com](http://www.intel.com), or from the OEM or retailer. No computer system can be absolutely secure. Software and workloads used in performance tests may have been optimized for performance only on Intel microprocessors.

# Intel Agilex 7 FPGA and SoC F-Series Features

Product Line		AGF 006	AGF 008	AGF 012
Resources	Logic elements (LEs)	573,480	764,640	1,178,525
	Adaptive logic modules (ALMs)	194,400	259,200	399,500
	ALM registers	777,600	1,036,800	1,598,000
	High-performance crypto blocks	0	0	0
	eSRAM memory blocks	0	0	2
	eSRAM memory size (Mb)	0	0	36
	M20K memory blocks	2,844	3,792	5,900
	M20K memory size (Mb)	56	74	115
	MLAB memory count	9,720	12,960	19,975
	MLAB memory size (Mb)	6	8	12
	I/O PLL	12	12	16
	Variable-precision digital signal processing (DSP) blocks	1,640	2,296	3,743
	18 x 19 multipliers	3,280	4,592	7,486
	Single-precision or half-precision floating point operations per second (TFLOPS)	2.5 / 5.0	3.5 / 6.9	6.0 / 12.0
	Maximum Available Device Resources	Maximum EMIF x72	2	2
Maximum differential (RX or TX) pairs		192	288	384
Maximum AIB interfaces		2	2	2
Memory devices supported				
Secure data manager		AES-256/SHA-256 bitstream encryption/authentication, physically unclonable function (PUF),		
Tile Resources	Hard processor system	Quad-core 64 bit Arm Cortex-A53 up to 1.50 GHz with 32 KB I/D cache, NEON coprocessor, 1 M serial peripheral interface (SPI) x4, I2C x5, general purpose timers x7, watchdog timer x4		
	F-Tile	PCI Express (PCIe) hard IP block (4.0 x16 ) or bifurcateable 2x PCIe 4.0 x8 (EP) or 4x 4.0 x4 (RP) Transceiver channel count : 16 channels at 32 Gbps (NRZ) /12 channels at 58 Gbps (PAM4) - RS Advanced networking support: - Bifurcateable 400 GbE hard IP block (10/25/50/100/200/400 GbE FEC/PCS/MAC) - Bifurcateable 200 Gb hard IP block (10/25/50/100/200 Gbps FEC/PCS) 300G Interlaken IEEE 1588 v2 support PMA direct		
	E-Tile	Transceiver channel count : Up to 24 channels at 28.9 Gbps (NRZ) / 12 channels at 58 Gbps (PAM4) Networking support : - 400GbE (4 x 100GbE hard IP blocks (10/25 GbE FEC/PCS/MAC)) IEEE 1588 v2 support PMA direct		
P-Tile	PCIe hard IP block (4.0 x16) or bifurcateable 2x PCIe 4.0 x8 (EP) or 4x 4.0 x4 (RP) SR-IOV 8PF / 2kVF VirtIO support Scalable IOV			

## F- Tile - Package Options and I/O Pins

1546A (F-Tile x2) (37.5 mm x 34 mm, 0.92 mm Hex)	384(192)/32(24)	384(192)/32(24)	
2340A (F-Tile x2) (45 mm x 42 mm, 0.92 mm Hex)	576 (288)/32(24)	576 (288)/32(24)	744(372)/32(24)
3184C (F-Tile x4) (56 mm x 45 mm, 0.92 mm Hex)			

## E-Tile and P-Tile - Package Options and I/O Pins

2486A (E-Tile x1 & P-Tile x1) (55 mm x 42.5 mm, 1.0 mm Hex)			768(384)/16(8)/16
2581A (E-Tile x1 & P-Tile x2) (50 mm x 40.5 mm, 0.92/0.94 mm Hex) <sup>2</sup>			

Notes:

1. Only 4 instances of KP-FEC are supported when using 100GE MAC.
2. Conditional migration path from AGF 019/023 to AGF 022/027 devices.



View device ordering codes on [page 55](#).

AGF 014	AGF 019	AGF 022	AGF 023	AGF 027
1,437,240	1,918,975	2,208,075	2,308,080	2,692,760
487,200	650,500	748,500	782,400	912,800
1,948,800	2,602,000	2,994,000	3,129,600	3,651,200
0	2	0	2	0
2	1	0	1	0
36	18	0	18	0
7,110	8,500	10,900	10,464	13,272
139	166	212	204	259
24,360	32,525	37,425	39,120	45,640
15	20	23	24	28
16	10	16	10	16
4,510	1,354	6,250	1,640	8,528
9,020	2,708	12,500	3,280	17,056
6.8 / 13.6	2.0 / 4.0	9.4 / 18.8	2.5 / 5.0	12.8 / 25.6
4	2	4	2	4
384	240	384	240	384
2	4	4	4	4

DDR4, QDR IV

ECDSA 256/384 boot code authentication, side-channel attack protection

16KB L2 cache, direct memory access (DMA), system memory management unit, cache coherency unit, hard memory controllers, USB 2.0x2, 1G EMAC x3, UART x2,

RS & KP FEC

M4) - RS & KP FEC<sup>1</sup>

**GPIO (LVDS) / F-Tile 32G NRZ (58G PAM4)**

744(372)/32(24)	480(240)/32(24)	744(372)/32(24)	480(240)/32(24)	744(372)/32(24)
	480(240)/64(48)	720(360)/64(48)	480(240)/64(48)	720(360)/64(48)

**GPIO (LVDS) / E-Tile 28.9G NRZ (57.8G PAM4) / P-Tile 16G PCIe**

768(384)/16(8)/16				
	480(240)/24(12)/32	624(312)/24(12)/32	480(240)/24(12)/32	624(312)/24(12)/32



# Intel Agilex 7 FPGA and SoC I-Series Feature

Product Line		AGI019	AGI023	
Resources	Logic elements (LEs)	1,918,975	2,308,080	
	Adaptive logic modules (ALMs)	650,500	782,400	
	ALM registers	2,602,000	3,129,600	
	High-performance crypto blocks	2	2	
	eSRAM memory blocks	1	1	
	eSRAM memory size (Mb)	18	18	
	M20K memory blocks	8,500	10,464	
	M20K memory size (Mb)	166	204	
	MLAB memory count	32,525	39,120	
	MLAB memory size (Mb)	20	24	
	Fabric PLL	5	5	
	I/O PLL	10	10	
	Variable-precision digital signal processing (DSP) blocks	1,354	1,640	
	18 x 19 multipliers	2,708	3,280	
	Single-precision or half-precision tera floating point operations per second (TFLOPS)	2.4 / 4.9	2.4 / 4.9	
Maximum Available Device Resources	Maximum EMIF x72 <sup>1</sup>	3	3	
	Maximum differential (RX or TX) pairs	240	240	
	Maximum AIB Interfaces	4	4	
	Memory devices supported			
	Secure data manager	AES-256/SHA-256 bitstream encryption or		
	Hard processor system	Quad-core 64 bit Arm Cortex-A53 up to 1.50 GHz with 32 KB I/D cache , NEO (DMA), system memory management unit, cache coherency unit, hard memo peripheral interface (SPI) x4, I2C x5, general purpose timers x7, watchdog tim		
Tile Resources	F-Tile	PCI Express(PCIe) hard IP block (4.0 x16 ) or Bifurcateable 2x PCIe 4.0 x8 (EP) Transceiver channel count : - 4 channels at 116 Gbps (PAM4) / 58 Gbps (NRZ) - 16 channels at 32 Gbps (NRZ) /12 channels at 58 Gbps (PAM4) - RS & KP F Advanced networking support: - Bifurcatable 400 GbE hard IP block (10/25/50/100/200/400 GbE FEC/PCS/ - Bifurcatable 200 Gb hard IP block (10/25/50/100/200 Gbs FEC/PCS) IEEE 1588 support PMA direct		
	R-Tile	Compute Express Interface (CXL) - Link width x16 lanes, x8 lanes PCIe hard IP block (5.0 x16) or Bifurcateable 2x PCIe 5.0 x8 (EP) or 4x 5.0 x4 (EP) Virtualization (SR-IOV) supporting 8 PFs/2k VFs Scalable IOV VirtIO support Precise time management PIPE direct		
<b>F-Tile - Package Options and I/O Pins</b>		<b>Tile Configuration</b>		<b>GPIO (LVDS)</b>
3184B (56 mm x 45 mm, 0.92 mm Hex)		F-Tile x4		480(240) / 64(48) / 8(8)
3948A (56mm x 56mm, 0.92 mm Hex)		F-Tile x6		480(240) / 64(48) / 8(8)
<b>F-Tile and R-Tile - Package Options and I/O Pins</b>		<b>Tile Configuration</b>		<b>GPIO (LVDS) / F-Tile 32G</b>
1805A (42.5mm x 42.5mm, 1.025 mm Hex)		F-Tile x1 & R-Tile x 1		480(240)/16(12)/0(0)/16(16)
2957A* (56 mm x 45 mm, 1.0 / 0.92 mm Hex)		F-Tile x1 & R-Tile x 3		720(360)
3184A (56 mm x 45 mm, 0.92 mm Hex)		F Tile x3 & R-Tile x1		720(360)

<sup>1</sup> Max EMIF count achieved using AVST x8 mode Compact - Address/Cmd lane [3 lanes] configuration

<sup>2</sup> Same HPS as AGI 027/022/023/019

\* Conditional pin migration from AGI 022/027 to AGI 041 device



View device ordering codes on [page 55](#).

AGI022	AGI027	AGI035	AGI040	AGI041
2,208,075	2,692,760	3,540,000	4,047,400	4,000,672
748,500	912,800	1,200,000	1,372,000	1,356,160
2,994,000	3,651,200	4,800,000	5,488,000	5,424,640
0	0	4	4	4
0	0	3	3	2
0	0	54	54	36
10,900	13,272	14,931	19,908	17,136
212	259	292	389	335
37,425	45,640	60,000	68,600	67,808
23	28	37	42	42
12	12	6	6	8
16	16	12	12	16
6,250	8,528	9,594	12,792	0
12,500	17,056	19,188	25,584	0
9.4 / 18.8	12.8 / 25.6	14.3 / 28.7	19.1 / 38.3	0
4	4	4	4	4
360	360	288	288	366
4	4	6	6	4
DDR4 and QDR IV				
authentication, physically unclonable function (PUF), ECDSA 256/384 boot code authentication, side channel attack protection				
N coprocessor, 1 MB L2 cache, direct memory access ry controllers, USB 2.0x2, 1G EMAC x3, UART x2, serial er x4		n/a		HPS support <sup>2</sup>
or 4x 4.0 x4 (RP)				
EC				
MAC)				
RP)				
<b>DS) / F-Tile 32G NRZ(58G PAM4) / High-Speed Transceiver 58G NRZ (116G PAM4) Channels</b>				
50) / 64(48) / 8(8)	720(360) / 64(48) / 8(8)			732(366)/64(48)/8(8)
		576(288) 96(72) / 24(24)	576(288) 96(72) / 24(24)	
<b>NRZ(58G PAM4) / High-Speed Transceiver 58G NRZ (116G PAM4) Channels / R- Tile 32G PCIe (CXL) Lanes</b>				
/16(12)/4(4)/48(32)	720(360)/16(12)/4(4)/48(32)			720(360)/16(12)/4(4)/48(32)
/48(36)/8(8)/16(16)	720(360)/48(36)/8(8)/16(16)			

# Intel Agilex 7 FPGA and SoC M-Series Features

View device ordering codes on [page 55](#).

Product Line		AGM 032	AGM 039
Resources	Logic elements (LEs)	3,245,000	3,851,520
	Adaptive logic modules (ALMs)	1,100,000	1,305,600
	ALM registers	4,400,000	5,222,400
	M20K memory blocks	15,932	18,960
	M20K memory size (Mb)	311	370
	MLAB memory count	55,000	65,280
	MLAB memory size (Mb)	33	40
	High-bandwidth DRAM memory size (HBM2E) (Gigabytes)	16 / 32	16 / 32
	Fabric PLL	8	8
	I/O PLL	16	16
	Variable-precision digital signal processing (DSP) blocks	9,375	12,300
	18 x 19 multipliers	18,750	24,600
	Single-precision or half-precision tera floating point operations per second (TFLOPS)	14 / 28	18.4 / 37
	Maximum EMIF x72	4	4
Maximum Available Device Resources	Memory devices supported	LPDDR5, DDR5, DDR4, QDR IV	
	Maximum AIB interfaces	4	
	Secure data manager	AES-256/SHA-256 bitstream encryption/authentication, physically unclonable function (PUF), ECDSA 256/384 boot code authentication, side-channel attack protection	
	Hard processor system	Quad-core 64 bit Arm Cortex-A53 up to 1.41 GHz with 32KB I/D cache, NEON coprocessor, 1 MB L2 cache, direct memory access (DMA), system memory management unit, cache coherency unit, hard memory controllers, USB 2.0 x2, 1G EMAC x3, UART x2, SPI x4, I2C x5, general purpose timers x7, watchdog timer x4	
Tile Resources	F-Tile	PCI Express (PCIe) hard IP block (4.0 x16 ) or bifurcateable 2x PCIe 4.0 x8 (EP) or 4x 4.0 x4 (RP) Transceiver channel count : - 4 channels at 116 Gbps (PAM4) / 58 Gbps (NRZ) - 16 channels at 32 Gbps (NRZ) /12 channels at 58 Gbps (PAM4) - RS & KP FEC Advanced networking support: - Bifurcateable 400 GbE hard IP block (10/25/50/100/200/400 GbE FEC/PCS/MAC) - Bifurcateable 200 Gb hard IP block (10/25/50/100/200 Gbps FEC/PCS) IEEE 1588 support PMA direct	
	R-Tile	Compute Express Link (CXL) - Link width x16 lanes, x8 lanes PCI Express (PCIe) hard IP block (5.0 x16 ) or bifurcateable 2x PCIe 5.0 x8 (EP) or 4x 5.0 x4 (RP) Virtualization (SR-IOV) supporting 8 PFs/2k VFs Scalable IOV VirtIO support Precise time management PIPE Direct	

Devices: Intel Agilex FPGA Portfolio

Product Line	AGM 032	AGM 039
<b>Package Options (Non-HBM2E Packages)</b>	<b>GPIO (LVDS) / F-Tile 32G NRZ (58G PAM4) / High-Speed Transceiver 58G NRZ (116G PAM4) / R- Tile 32G PCIe (CXL) Lanes</b>	
3695B (F-Tile x4) (56 mm x 52.5 mm, 0.92 mm Hex)	768(384) / 64(48) / 8(8)	768 (384) / 64(48) / 8(8)
3695A (F-Tile x3, R-Tile x1) (56 mm x 52.5 mm, 0.92 mm Hex)	768(384) / 48(36) / 8(8) / 16(16)	768(384) / 48(36) / 8(8) / 16(16)

Product Line	AGM 032	AGM 039
<b>Package Options (HBM2E Packages)</b>	<b>GPIO (LVDS) / F-Tile 32G NRZ (58G PAM4) / High-Speed Transceiver 58G NRZ (116G PAM4) / R- Tile 32G PCIe (CXL) Lanes</b>	
4700A (F-Tile x3, R-Tile x1, HBM2E) (56 mm x 66 mm, 0.92 mm Hex)	768(384) / 48(36) / 8(8) / 16(16)	768(384) / 48(36) / 8(8) / 16(16)
4700B (F-Tile x4, HBM2E) (56 mm x 66 mm, 0.92 mm Hex)	768(384) / 64(48) / 8(8)	768(384) / 64(48) / 8(8)

# Intel Agilex 5 FPGA and SoC Overview

## Intel Agilex 5 Devices



Intel Agilex 5 devices serve a broad range of applications that require high performance, lower power, and smaller form factors. This tier consists of the performance-optimized D-Series FPGAs and the power-optimized E-Series FPGAs. Intel Agilex 5 devices also feature the industry's first Enhanced DSP with AI Tensor Block, which deliver high-efficiency AI and digital signal processing (DSP) functionality, and the FPGA industry's first asymmetric applications processor system consisting of dual Arm Cortex-A76 cores and dual Cortex-A55 cores, which enable you to optimize the performance and power efficiency of their workloads. These characteristics make them ideal for midrange FPGA applications across the edge and core including wireless and wireline communications, video and broadcast equipment, industrial applications, test and measurement products, medical electronics, and defense applications.

### E-Series FPGAs and SoCs

E-Series FPGAs and SoCs are optimized for power and size— with 50% lower power while delivering up to 2.5X better performance as compared to Cyclone V devices, also with features including transceiver rates up to 24x28 Gbps, PCIe 4.0x4, 6x25GbE, 3,600 Mbps DDR5, dual core of A55 and dual core of A76 make it ideal for intelligent applications at the edge, embedded, and more.

### D-Series FPGAs and SoCs

D-Series FPGAs and SoCs are optimized for performance and power efficiency— with 42% lower power while delivering up to 1.5X better performance as compared to Intel Stratix 10 FPGAs, also with features including transceiver rates up to 32x28 Gbps, PCIe 4.0x8, 16x25GbE, 4,000 Mbps DDR5, dual core of A55 and dual core of A76 make it deal for various applications across multiple markets.

## Image Sensor Processing

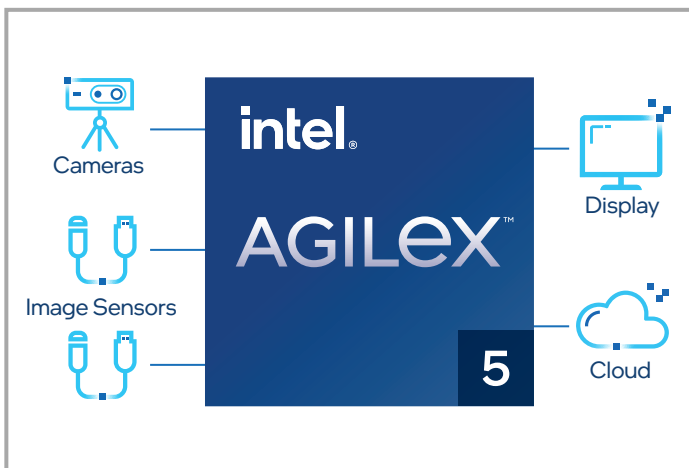

### Inline image processing

- Pixel defect correction
- Vignette correction
- Adaptive noise reduction

### Customized Connectivity

- High-definition multimedia interface (HDMI)
- MIPI D-PHY

### Hard Processor System

- Flexible embedded software stack
- Graphical user interface

## Autonomous Mobile Robots

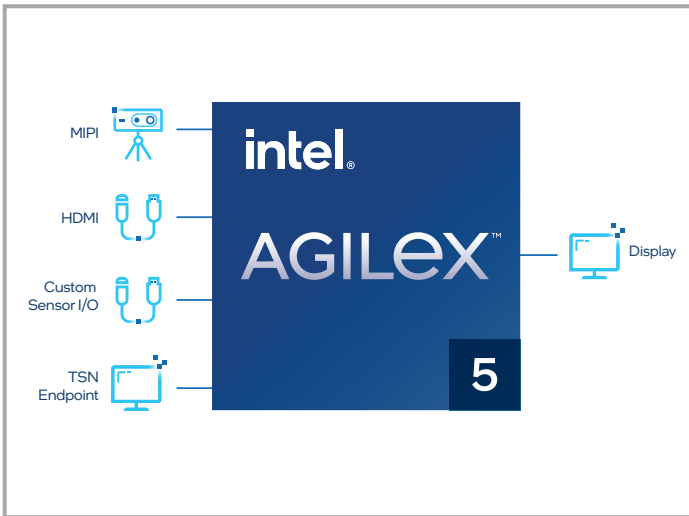

### Flexible I/O

- MIPI
- HDMI
- Time-Sensitive Networking (TSN)
- LVDS

### FPGA Acceleration

- Sensor fusion
- Point of cloud processing

### Hard Processor System

- RTOS
- Hypervisor functions
- Network features
- User application

## Clinical System

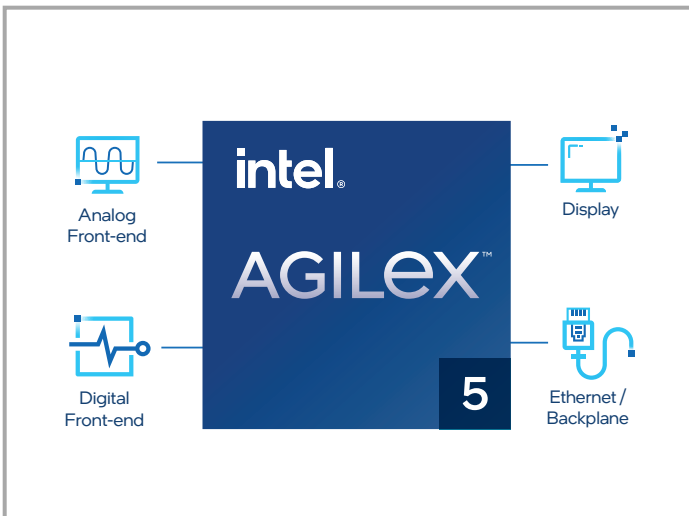

### Power Optimized

- Low-density option
- Battery-powered clinical equipment

### FPGA Acceleration

- Custom image processing
- AR/VR innovations
- Deterministic low latency

### Hard Processor System

- Real-time waveform analysis
- Graphic controls for Human-Machine Interaction (HMI)

# Intel Agilex 5 FPGA and SoC E-Series Features

Product Line		Device Group A FPGAs				
		A5E 013A	A5E 028A	A5E 043A	A5E 052A	A5E 065A
Resources	Logic elements (LEs)	138,060	282,256	434,240	523,920	656,080
	Adaptive logic modules (ALMs)	46,800	95,680	147,200	177,600	222,400
	ALM registers	187,200	382,720	588,800	710,400	889,600
	M20K memory blocks	358	716	1,050	1,288	1,611
	M20K memory size (Mb)	6.99	13.98	20.51	25.16	31.46
	MLAB memory count	2,340	4,784	6,720	8,440	11,120
	MLAB memory size (Mb)	1.43	2.92	4.10	5.15	6.79
	I/O PLL	4	4	8	8	8
	Fabric-feeding I/O PLL <sup>1</sup>	8	10	11	13	13
	Variable-precision digital signal processing (DSP) blocks	188	376	564	676	846
	18 x 19 multipliers	376	752	1,128	1,352	1,692
	Peak TOPS INT8	5.78	11.55	17.33	20.78	25.99
	Maximum Available Device Resources	LVDS pairs at 1.6 Gbps	96	96	192	192
DDR4/5 and LPDDR4/5 interfaces (x32)		2	2	4	4	4
MIPI D-PHY interface		14	14	28	28	28
Differential (RX or TX) pairs at 28 Gbps		4	12	16	24	24
PCIe 4.0 x4 instance		1	3	4	6	6
High-speed I/O (HSIO)		192	192	384	384	384
High-voltage I/O (HVIO)		200	200	120	120	120
Secure data manager		Secure data manager AES-256/SHA-256/384 bitstream encryption/authentication, physically unclonable function (PUF), ECDSA 256/384 boot code authentication, secure boot, platform attestation, anti-tamper features, vendor authorized boot, black key provisioning				
Hard processor system		Multi-core with 32-bit/64-bit dual-core Arm Cortex-A55 up to 1.5 GHz with 32 KB I/D cache and 128 KB L2 cache, and dual-core Arm Cortex-A76 up to 1.8 GHz with 64 KB I/D cache and 256 KB L2 cache, and up to 2 MB L3 shared cache, multi-channels direct memory access (DMA), 512 KB on-chip RAM, USB 3.1 x1, USB 2.0 OTG x2, TSN MAC x3, UART x2, SPI M x2, SPI S x2, I3C x2, I2C x5, NAND x1, SDMMC x1, Osc timer x2, SP timer x2, watchdog x5, GPIO x2.				
Transceiver		PCI Express (PCIe) hard IP up to PCIe 4.0 x4 EP and RP Transceiver channel count: up to 24 channels at 28 Gbps (NRZ) Ethernet IP: up to 6 x10/25 GbE hard IP (MAC, PCS, and FEC)				

## Package Options and I/O Pins

Package code (Package size, minimum ball pitch, grid array pattern)	HVIO/HSIO/Transceivers				
B23A <sup>2</sup> (23 mm x 23 mm, 0.65 mm, balls anywhere)	120/96/4	120/96/12	120/96/12	120/96/12	120/96/12
B32A <sup>2</sup> (32 mm x 32 mm, 0.65 mm, balls anywhere)	200/192/4	200/192/12	120/384/16	120/384/24	120/384/24

- Notes:
- The Fabric-feeding IOPLL count inclusive of system PLL at transceiver bank, the System PLL can be repurposed for core fabric usage if not used for transceiver.
  - Conditional migration path between Device Group A FPGAs and Device Group B FPGAs, please refer to Intel Agilex 5 Device Migration Guidelines Application Note (to be published in Q2'23) for migration details

Product Line		Device Group B FPGAs								
		A5E 005B	A5E 007B	A5E 008B	A5E 013B	A5E 028B	A5E 043B	A5E 052B	A5E 065B	
Resources	Logic elements (LEs)	50,445	69,030	85,196	138,060	282,256	434,240	523,920	656,080	
	Adaptive logic modules (ALMs)	17,100	23,400	28,880	46,800	95,680	147,200	177,600	222,400	
	ALM registers	68,400	93,600	115,520	187,200	382,720	588,800	710,400	889,600	
	M20K memory blocks	130	179	229	358	716	1,050	1,288	1,611	
	M20K memory size (Mb)	2.54	3.50	4.47	6.99	13.98	20.51	25.16	31.46	
	MLAB memory count	850	1,170	1,780	2,340	4,784	6,720	8,440	11,120	
	MLAB memory size (Mb)	0.52	0.71	1.09	1.43	2.92	4.10	5.13	6.79	
	I/O PLL	2	2	4	4	4	8	8	8	
	Fabric-feeding I/O PLL <sup>1</sup>	5	5	8	8	10	11	13	13	
	Variable-precision digital signal processing (DSP) blocks	65	94	116	188	376	564	676	846	
	18 x 19 multipliers	130	188	232	376	752	1,128	1,352	1,692	
	Peak TOPS INT8	1.7	2.46	3.05	4.93	9.85	14.46	17.72	22.17	
Maximum Available Device Resources	LVDS pairs at 1.6 Gbps	48	48	96	96	96	192	192	192	
	DDR4 and LPDDR4/5 interfaces (x32)	1	1	2	2	2	4	4	4	
	MIPI D-PHY interface	7	7	14	14	14	28	28	28	
	Differential (RX or TX) pairs at 17 Gbps	0	0	4	4	12	16	24	24	
	PCIe 4.0 x4 instance	0	0	1	1	3	4	6	6	
	High-speed I/O (HSIO)	96	96	192	192	192	384	384	384	
	High-voltage I/O (HVIO)	160	160	200	200	200	120	120	120	
	Secure data manager	Secure data manager AES-256/SHA-256/384 bitstream encryption/authentication, physically unclonable function (PUF), ECDSA 256/384 boot code authentication, secure boot, platform attestation, anti-tamper features, vendor authorized boot, black key provisioning								
	Hard processor system	NA		Multi-core with 32-bit/64-bit dual-core Arm Cortex-A55 up to 1.33 GHz with 32 KB I/D cache and 128 KB L2 cache, and dual-core Arm Cortex-A76 up to 1.6 GHz with 64 KB I/D cache and 256 KB L2 cache, and up to 2 MB L3 shared cache, multi-channels direct memory access (DMA), 512 KB on-chip RAM, USB 3.1 x1, USB 2.0 OTG x2, TSN MAC x3, UART x2, SPI M x2, SPI S x2, I3C x2, I2C x5, NAND x1, SDMMC x1, Osc timer x2, SP timer x2, watchdog x5, GPIO x2.						
	Transceiver	NA		PCI Express (PCIe) hard IP up to PCIe 4.0 x4 EP and RP Transceiver channel count: up to 24 channels at 17 Gbps (NRZ) Ethernet IP: up to 6 x10 GbE hard IP (MAC, PCS, and FEC)						

Package Options and I/O Pins

Package code ( Package size, minimum ball pitch, grid array pattern)	HVIO/HSIO/Transceivers							
B15A (15 mm x15 mm, 0.65 mm, balls anywhere)	80/62	80/62						
M16A (16 mm x16 mm, 0.5 mm, standard)			40/192/4	40/192/4	40/192/8			
B18A (18mm x 18mm, 0.65 mm, balls anywhere)	160/52	160/52						
B23B (23 mm x23 mm, 0.65 mm, balls anywhere)	160/96	160/96	160/192	160/192	160/192			
B23A <sup>2</sup> (23 mm x23 mm, 0.65 mm, balls anywhere)			120/96/4	120/96/4	120/96/12	120/96/12	120/96/12	120/96/12
B32A <sup>2</sup> (32 mm x 32 mm, 0.65 mm, balls anywhere)			200/192/4	200/192/4	200/192/12	120/384/16	120/384/24	120/384/24

Notes:  
 1. The Fabric-feeding IOPLL count inclusive of system PLL at transceiver bank, the System PLL can be repurposed for core fabric usage if not used for transceiver.  
 2. Conditional migration path between Device Group A FPGAs and Device Group B FPGAs, please refer to Intel Agilix 5 Device Migration Guidelines Application Note (to be published in Q2'23) for migration details



# Intel Agilex 5 FPGA and SoC D-Series Features

Product Line		A5D 010	A5D 025	A5D 031	A5D 051	A5D 064
Resources	Logic elements (LEs)	103,250	254,054	318,600	515,070	644,280
	Adaptive logic modules (ALMs)	35,000	86,120	108,000	174,600	218,400
	ALM registers	140,000	344,480	432,000	698,400	873,600
	M20K memory blocks	534	1,281	1,602	2,563	3,204
	M20K memory size (Mb)	10.43	25.02	31.29	50.06	62.58
	MLAB memory count	1780	3420	5,400	8,440	10,920
	MLAB memory size (Mb)	1.09	2.09	3.30	5.15	6.67
	I/O PLL	8	8	8	8	8
	Fabric-feeding I/O PLL <sup>1</sup>	11	11	11	13	13
	Variable-precision digital signal processing (DSP) blocks	276	736	920	1,472	1,840
	18 x 19 multipliers	552	1,472	1,840	2,944	3,680
	Peak TOPS INT8	8.48	22.61	28.26	45.22	56.22
	Maximum Available Device Resources	LVDS pairs at 1.6 Gbps	192	192	192	192
DDR4 interface (x64)		2	2	2	2	2
DDR4/5 and LPDDR4/5 interfaces (x32)		4	4	4	4	4
MIPI D-PHY interface		28	28	28	28	28
Differential (RX or TX) pairs at 28 Gbps		16	16	16	24	32
PCIe 4.0 x4 instance		4	4	4	6	8
PCIe 4.0 x8 instance		2	2	2	3	4
High-speed I/O (HSIO)		384	384	384	384	384
High-voltage I/O (HVIO)		60	60	60	60	60
Secure data manager		Secure data manager AES-256/SHA-256/384 bitstream encryption/authentication, physically unclonable function (PUF), ECDSA 256/384 boot code authentication, secure boot, platform attestation, anti-tamper features, vendor authorized boot, black key provisioning				
Hard processor system		Multi-core with 32-bit/64-bit dual-core Arm Cortex-A55 up to 1.5 GHz with 32 KB I/D cache and 128 KB L2 cache, and dual-core Arm Cortex-A76 up to 1.8 GHz with 64 KB I/D cache and 256 KB L2 cache, and up to 2 MB L3 shared cache, multi-channels direct memory access (DMA), 512 KB on-chip RAM, USB3.1 x1, USB 2.0 OTG x2, TSN MAC x3, UART x2, SPI M x2, SPI S x2, I3C x2, I2C x5, NAND x1, SDMMC x1, Osc timer x2, SP timer x2, watchdog x5, GPIO x2.				
Transceiver	PCI Express (PCIe) hard IP up to PCIe 4.0 x8 EP and RP Transceiver channel count: up to 32 channels at 28 Gbps (NRZ) Ethernet IP: up to 16 x10/25 GbE hard IP (MAC, PCS, and FEC)					
<b>Package Options and I/O Pins</b>						
<b>Package code</b> (Package size, minimum ball pitch, grid array pattern)		<b>HVIO/ HSIO/Transceivers</b>				
B23A (23 mm x23 mm, 0.65 mm, balls anywhere)		60/192/8	60/192/8	60/192/8		
B32A (32 mm x 32 mm, 0.65 mm, balls anywhere)		60/384/16	60/384/16	60/384/16	60/384/24	60/384/32

**Note:**

1. The Fabric-feeding IOPLL count inclusive of system PLL at transceiver bank, the System PLL can be repurposed for core fabric usage if not used for transceiver.

# Generation 10 FPGAs and SoCs

Intel's Generation 10 FPGAs and SoCs are optimized based on process technology and architecture to deliver the industry's highest performance and highest levels of system integration at the lowest power. Generation 10 device families include Intel Stratix 10 FPGAs and SoCs, Intel Arria 10 FPGAs and SoCs, Intel Cyclone 10 FPGAs, and Intel MAX 10 FPGAs.

## Intel® Stratix® 10

FPGA • SoC

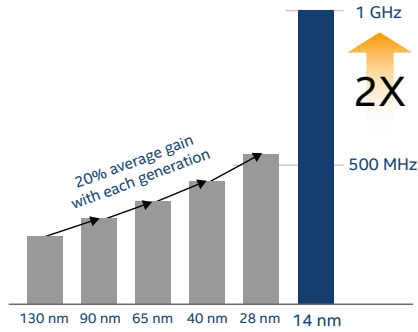

- 2X core performance with revolutionary Intel Hyperflex FPGA Architecture†
- Up to 70% power savings†
- Highest density FPGA with up to 10.2 M logic elements (LEs)
- 64 bit quad-core Arm Cortex-A53 processor system
- Up to 10 tera floating point operations per second (TFLOPS) single-precision floating-point throughput
- Built on Intel's 14 nm Tri-Gate process technology

## Intel® Arria® 10

FPGA • SoC

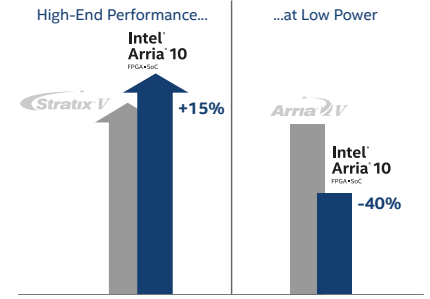

- 15% higher performance than the previous high-end devices†
- 40% lower midrange power†
- 1.5 GHz dual-core Arm Cortex-A9 processor
- IP core support, including 100G Ethernet, 150G/300G Interlaken, and PCI Express 3.0
- Built on TSMC's 20 nm process technology

## Intel® Cyclone® 10

FPGA

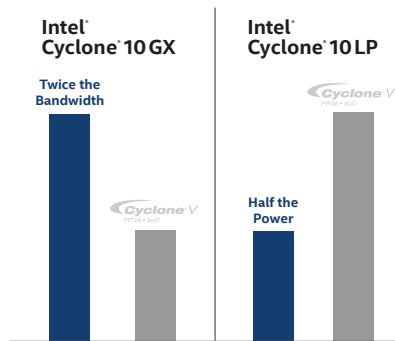

### Intel Cyclone 10 GX

- Optimized for high-bandwidth, high-performance applications
- The industry's first low-cost FPGA with 12.5 Gbps transceiver I/O support
- High-performance 1,866 Mbps external memory interface
- 1.434 Gbps LVDS I/Os
- The industry's first low-cost FPGA with IEEE 754 compliant hard floating-point DSP blocks

### Intel Cyclone 10 LP

- Optimized for cost and power-sensitive applications
- Chip-to-chip bridging
- I/O expansion
- Control applications

## Intel® MAX® 10

FPGA

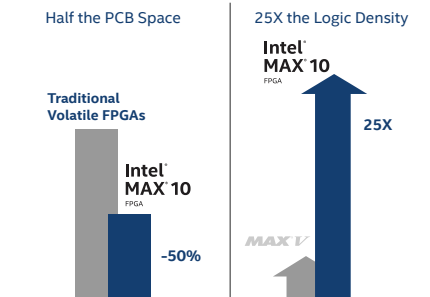

- Single-chip, dual-configuration non-volatile FPGA
- Optimal system component integration for half the PCB space of traditional volatile FPGAs
- Broad range of IP including analog-to-digital converters (ADCs), DSP, and the Nios II embedded soft processor

# Intel Stratix 10 FPGA and SoC Overview

[intel.com/stratix10](https://intel.com/stratix10)

Intel FPGAs and SoCs deliver breakthrough advantages in performance, power efficiency, density, and system integration that are unmatched in the industry. Featuring the revolutionary Intel Hyperflex FPGA Architecture and built on the Intel 14 nm Tri-Gate process, Intel Stratix 10 devices deliver 2X core performance gains over previous-generation, high-performance FPGAs with up to 70% lower power<sup>†</sup>.

## Intel® Stratix® 10 Device Family Variants

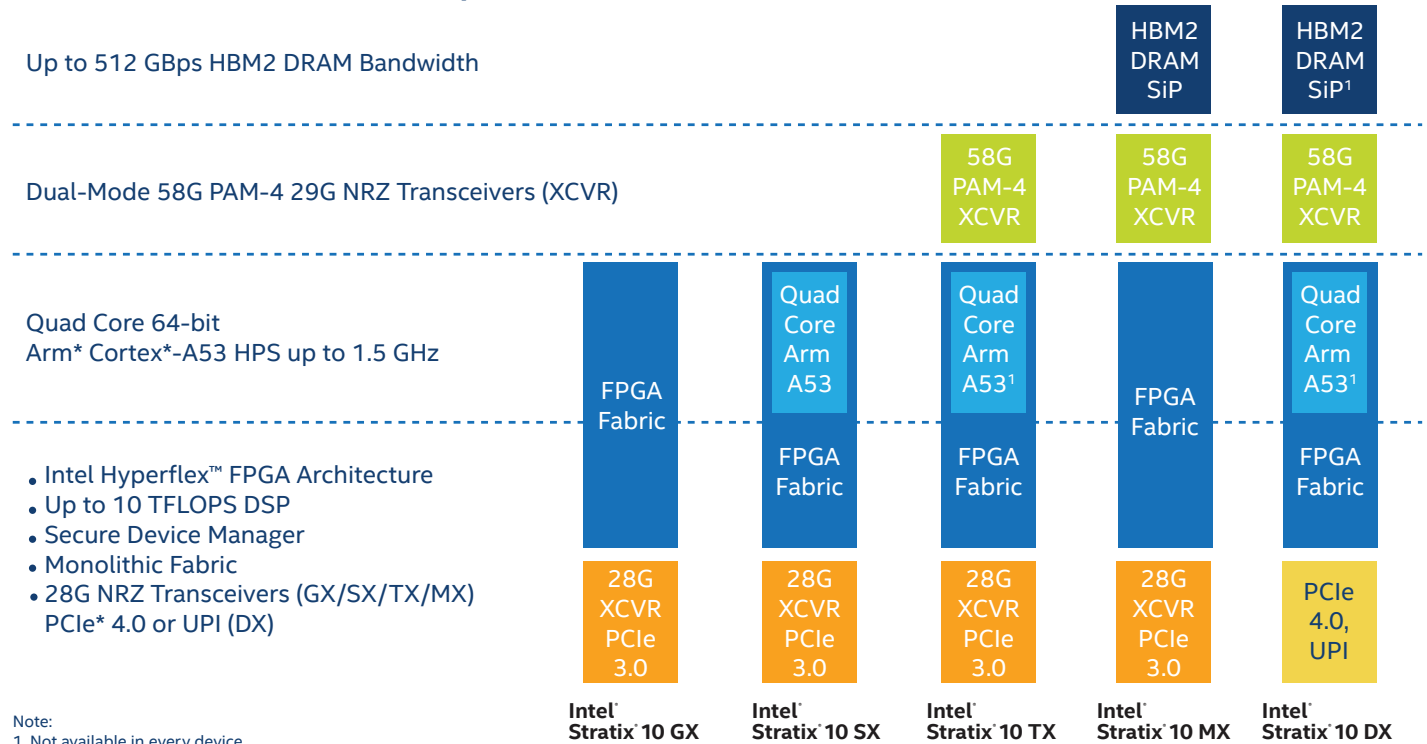

The figure above shows the core performance benchmarks achieved by early access customers using the Intel Stratix 10 Hyperflex FPGA architecture. With the 2X performance increase, customers in multiple end markets can achieve significant improvements in both throughput and area utilization, with up to 70% lower power<sup>†</sup>.

Intel Stratix 10 FPGA and SoC system integration breakthroughs include:

- Heterogeneous 3D system in package (SiP) integration
- The highest density FPGA fabric with up to 10.2 million LEs
- Up to 10 TFLOPS of IEEE 754 compliant single-precision floating-point DSP throughput
- Secure Device Manager (SDM) with the most comprehensive security capabilities
- Integrated quad-core 64 bit Arm Cortex-A53 hard processor system up to 1.5 GHz
- Dual-mode 28.9 Gbps non-return-to-zero (NRZ) and 57.8 Gbps PAM-4 transceivers
- HBM2 DRAM SiP delivering up to 512 GBps of memory bandwidth

## Devices: Generation 10 Device Portfolio

These unprecedented capabilities make Intel Stratix 10 devices uniquely positioned to address the design challenges in next-generation, high-performance systems in virtually all end markets including wireline and wireless communications, computing, storage, military, broadcast, medical, and test and measurement.

### Communications



- 400G/500G/1T optical transmission
- 200G/400G bridging and aggregation
- 982 MHz remote radio head
- Mobile backhaul
- 5G wireless communications

### Computing and Storage



- Data center server acceleration
- High-performance computing (HPC)
- Oil and gas exploration
- Bioscience

### Defense



- Next-generation radar
- Secure communications
- Avionics and guidance systems

### Broadcast



- High-end broadcast studio
- High-end broadcast distribution
- Headend encoder or EdgeQAM or converged multiservice access platform (CMAP)

# Intel Stratix 10 GX FPGA Features

Product Line		GX 400	GX 650	GX 850	GX 1100
Resources	Logic elements (LEs) <sup>1</sup>	378,000	612,000	841,000	1,325,000
	Adaptive logic modules (ALMs)	128,160	207,360	284,960	449,280
	ALM registers	512,640	829,440	1,139,840	1,797,120
	Hyper-Registers from Intel Hyperflex FPGA Architecture				Millions of Hyperflex Registers
	Programmable clock trees synthesizable				
	M20K memory blocks	1,537	2,489	3,477	5,461
	M20K memory size (Mb)	30	49	68	107
	MLAB memory size (Mb)	2	3	4	7
	Variable-precision digital signal processing (DSP) blocks	648	1,152	2,016	2,592
	18 x 19 multipliers	1,296	2,304	4,032	5,184
	Peak fixed-point performance (TMACS) <sup>2</sup>	2.6	4.6	8.1	10.4
Peak floating-point performance (TFLOPS) <sup>3</sup>	1.0	1.8	3.2	4.1	
I/O and Architectural Features	Secure device manager	AES-256/SHA-256 bitstream encryption/authentication, physical unclonable functions			
	Hard processor system <sup>4</sup>	Quad-core 64-bit Arm Cortex-A53 up to 1.5 GHz with 32KB I/D cache, NEON coprocessor, cache coherency unit, hard memory controllers, USB 2.0 x2, 1G EMAC x3, UART			
	Maximum user I/O pins	374	392	688	688
	Maximum LVDS pairs 1.6 Gbps (RX or TX)	120	192	336	336
	Total full duplex transceiver count	24	24	48	48
	GXT full duplex transceiver count (up to 28.3 Gbps)	16	16	32	32
	GX full duplex transceiver count (up to 17.4 Gbps)	8	8	16	16
	PCI Express hard intellectual property (IP) blocks (3.0 x16)	1	1	2	2
Memory devices supported	DDR4, DDR3L, LPDDR4, LPDDR3L				
<b>Package Options and I/O Pins: General-Purpose I/O (GPIO) Count, High-Voltage I/O Count, LVDS Pairs, and Transceiver Count<sup>7,8</sup></b>					
F1152 pin (35 mm x 35 mm, 1.0 mm pitch)	374,56,120,24	392,8,192,24	–	–	
F1760 pin (42.5 mm x 42.5 mm, 1.0 mm pitch)	–	–	688,16,336,48	688,16,336,48	
F2397 pin (50 mm x 50 mm, 1.0 mm pitch)	–	–	–	–	
F2912 pin (55 mm x 55 mm, 1.0 mm pitch)	–	–	–	–	
F4938 pin (70 mm x 74 mm, 1.0 mm pitch)	–	–	–	–	

- Notes:
- LE counts valid in comparing across Intel FPGAs, and are conservative vs. competing FPGAs.
  - Fixed point performance assumes the use of pre-adder.
  - Floating point performance is IEEE-754 compliant single-precision.
  - Quad-core Arm Cortex-A53 hard processor system only available in Intel Stratix 10 SX SoCs.
  - 1.4 Gbps LVDS maximum rate for GX 10M.
  - PCIe 3.0 x 8 support for GX 10M.
  - A subset of pins for each package are used for high-voltage 3.0 V and 2.5 V interfaces.
  - All data is preliminary and subject to change without prior notice.

392,8,192,24 Numbers indicate total GPIO count, high-voltage I/O count, LVDS pairs, and transceiver count.

Indicates pin migration path.

View device ordering codes on [page 56](#).

GX 1650	GX 2100	GX 2500	GX 2800	GX 1660	GX 2110	GX 10M
1,624,000	2,005,000	2,422,000	2,753,000	1,679,000	2,073,000	10,200,000
550,540	679,680	821,150	933,120	569,200	702,720	3,466,080
2,202,160	2,718,720	3,284,600	3,732,480	2,276,800	2,810,880	13,864,320
r-Registers distributed throughout the monolithic FPGA fabric						
Hundreds of synthesizable clock trees						
5,851	6,501	9,963	11,721	6,162	6,847	12,950
114	127	195	229	120	134	253
8	11	13	15	9	11	55
3,145	3,744	5,011	5,760	3,326	3,960	3,456
6,290	7,488	10,022	11,520	6,652	7,920	6,912
12.6	15.0	20.0	23.0	13.3	15.8	13.8
5.0	6.0	8.0	9.2	5.3	6.3	5.5
sically unclonable function (PUF), ECDSA 256/384 boot code authentication, side-channel attack protection						-
r, 1 MB L2 cache, direct memory access (DMA), system memory management unit, cache ART x2, SPI x4, I2C x5, general purpose timers x7, watchdog timer x4				-	-	-
704	704	1160	1160	688	688	2,304
336	336	576	576	336	336	1152 <sup>5</sup>
96	96	96	96	48	48	48
64	64	64	64	32	32	-
32	32	32	32	16	16	48
4	4	4	4	2	2	4 <sup>6</sup>
R3, DDR2, DDR, QDR II, QDR II+, RLD RAM II, RLD RAM 3, HMC, MoSys						
-	-	-	-	-	-	-
688,16,336,48	688,16,336,48	688,16,336,48	688,16,336,48	688,16,336,48	688,16,336,48	-
704,32,336,96	704,32,336,96	704,32,336,96	704,32,336,96	-	-	-
-	-	1160,8,576,24	1160,8,576,24	-	-	-
						2304, 32, 1152, 48

# Intel Stratix 10 TX FPGA Features

Product Line	TX 400	TX 850	TX 850	TX 1100	TX 1100	TX 1650	
Resources	Logic elements (LEs) <sup>1</sup>	378,000	841,000	841,000	1,325,000	1,325,000	1,679,000
	Adaptive logic modules (ALMs)	128,160	284,960	284,960	449,280	449,280	569,200
	ALM registers	512,640	1,139,840	1,139,840	1,797,120	1,797,120	2,276,800
	Hyper-Registers from Intel Hyperflex FPGA Architecture	Millions of Hyper-Registers distributed throughout					
	Programmable clock trees synthesizable	Hundreds of synthesizable clock					
	eSRAM memory blocks	–	–	–	–	–	2
	eSRAM memory size (Mb)	–	–	–	–	–	94.5
	M20K memory blocks	1,537	3,477	3,477	5,461	5,461	6,162
	M20K memory size (Mb)	30	68	68	107	107	120
	MLAB memory size (Mb)	2	4	4	7	7	9
	Variable-precision digital signal processing (DSP) blocks	648	2,016	2,016	2,592	2,592	3,326
	18 x 19 multipliers	1,296	4,032	4,032	5,184	5,184	6,652
	Peak fixed-point performance (TMACS) <sup>2</sup>	2.6	8.1	8.1	10.4	10.4	13.3
Peak floating-point performance (TFLOPS) <sup>3</sup>	1.0	3.2	3.2	4.1	4.1	5.3	
I/O and Architectural Features	Secure device manager	AES-256/SHA-256 bitstream encryption/authentication, physically unclonable function (PUF), ECC					
	Hard processor system <sup>4</sup>	Quad-core 64-bit Arm Cortex-A53 up to 1.5 GHz with 32KB I/D cache, NEON coprocessor, 1 MB L2 cache coherency unit, hard memory controllers, USB 2.0 x2, 1G EMAC x3, UART x2, SPI					
		Yes	Yes	Yes	Yes	Yes	–
	Maximum user I/O pins	384	440	440	440	440	440
	Maximum LVDS pairs 1.6 Gbps (RX or TX)	144	216	216	216	216	216
	Total full duplex transceiver count	24	48	72	48	72	96
	GXE transceiver count - PAM4 (up to 57.8 Gbps) or NRZ (up to 28.9 Gbps)	12 PAM-4 24 NRZ	12 PAM-4 24 NRZ	24 PAM-4 48 NRZ	12 PAM-4 24 NRZ	24 PAM-4 48 NRZ	36 PAM-4 72 NRZ
	GXT transceiver count - NRZ (up to 28.3 Gbps)	0	16	16	16	16	16
	GX transceiver count - NRZ (up to 17.4 Gbps)	0	8	8	8	8	8
	PCI Express hard intellectual property (IP) blocks (3.0 x16)	0	1	1	1	1	1
	100G Ethernet MAC (no FEC) hard IP blocks	0	1	1	1	1	1
100G Ethernet MAC + FEC hard IP blocks	4	4	8	4	8	12	
Memory devices supported	DDR4, DDR3, DDR2, DDR, QDR II, QDR II+, RDRAM						
<b>Package Options and I/O Pins: General-Purpose I/O (GPIO) Count, High-Voltage I/O Count, LVDS Pairs, E-Tile Transceiver Count and H-Tile Transceiver Count<sup>5,6</sup></b>							
F1152 pin (35mm x 35mm, 1.0mm pitch)	384,0,144,24,0						
F1760 pin (42.5 mm x 42.5 mm, 1.0 mm pitch)		440,8,216,24,24	–	440,8,216,24,24	–	–	
F2397 pin (50 mm x 50 mm, 1.0 mm pitch)	–	–	440,8,216,48,24	–	440,8,216,48,24	440,8,216,72,24	
F2912 pin (55 mm x 55 mm, 1.0 mm pitch)	–	–	–	–	–	–	

- Notes:
- LE counts valid in comparing across Intel FPGAs, and are conservative vs. competing FPGAs.
  - Fixed point performance assumes the use of pre-adder.
  - Floating point performance is IEEE-754 compliant single-precision.
  - Quad-core Arm Cortex-A53 hard processor system present in select Intel Stratix 10 TX devices.
  - A subset of pins for each package are used for high-voltage 3.0 V and 2.5 V interfaces.
  - All data is preliminary and subject to change without prior notice.

296,8,144,120,24 Numbers indicate total GPIO count, high-voltage I/O count, LVDS pairs, GXE (E-Tile) transceiver count, and GXT+GX (H-Tile) transceiver count  
 Indicates pin migration path.

View device ordering codes on [page 56](#).

TX 2100	TX 2500	TX 2500	TX 2800	TX 2800
2,073,000	2,422,000	2,422,000	2,753,000	2,753,000
702,720	821,150	821,150	933,120	933,120
2,810,880	3,284,600	3,284,600	3,732,480	3,732,480

the monolithic FPGA fabric

Block trees	TX 2100	TX 2500	TX 2500	TX 2800	TX 2800
2	-	-	-	-	-
94.5	-	-	-	-	-
6,847	9,963	9,963	11,721	11,721	
134	195	195	229	229	
11	13	13	15	15	
3,960	5,011	5,011	5,760	5,760	
7,920	10,022	10,022	11,520	11,520	
15.8	20.0	20.0	23.0	23.0	
6.3	8.0	8.0	9.2	9.2	

ECDSA 256/384 boot code authentication, side-channel attack protection

2 cache, direct memory access (DMA), system memory management unit, SPI x4, I2C x5, general purpose timers x7, watchdog timer x4

	TX 2100	TX 2500	TX 2500	TX 2800	TX 2800
-	Yes	Yes	Yes	Yes	Yes
440	440	296	440	296	296
216	216	144	216	144	144
96	96	144	96	144	144
36 PAM-4 72 NRZ	36 PAM-4 72 NRZ	60 PAM-4 120 NRZ	36 PAM-4 72 NRZ	60 PAM-4 120 NRZ	60 PAM-4 120 NRZ
16	16	16	16	16	16
8	8	8	8	8	8
1	1	1	1	1	1
1	1	1	1	1	1
12	12	20	12	20	20

II, RLD RAM 3, HMC, MoSys

	TX 2100	TX 2500	TX 2500	TX 2800	TX 2800
-	-	-	-	-	-
0,8,216,72,24	440,8,216,72,24	-	440,8,216,72,24	-	-
-	-	296,8,144,120,24	-	296,8,144,120,24	-

Product Line	Hard Processor System (HPS)
Processor	Quad-core 64 bit Arm Cortex-A53 MPCore processor
Maximum processor frequency	1.5 GHz <sup>1</sup>
Processor cache and co-processors	<ul style="list-style-type: none"> <li>L1 instruction cache (32 KB)</li> <li>L1 data cache (32 KB) with error correction code (ECC)</li> <li>Level 2 cache (1 MB) with ECC</li> <li>Floating-point unit (FPU) single and double precision</li> <li>Arm NEON media engine</li> <li>Arm CoreSight debug and trace technology</li> <li>System Memory Management Unit (SMMU)</li> <li>Cache Coherency Unit (CCU)</li> </ul>
Scratch pad RAM	256 KB
HPS DDR memory	DDR4 and DDR3 (Up to 64 bit with ECC)
DMA controller	8 channels
EMAC	3X 10/100/1000 Ethernet media access controller (EMAC) with integrated DMA
USB On-The-Go (OTG) controller	2X USB OTG with integrated DMA
UART controller	2X UART 16550 compatible
Serial peripheral interface (SPI) controller	4X SPI
I <sup>2</sup> C controller	5X I <sup>2</sup> C
Quad SPI flash controller	1X SIO, DIO, QIO SPI flash supported
SD/SDIO/MMC controller	1X eMMC 4.5 with DMA and CE-ATA support
NAND flash controller	<ul style="list-style-type: none"> <li>1X ONFI 1.0 or later</li> <li>8 and 16 bit support</li> </ul>
General-purpose timers	4X
Software-programmable general-purpose I/Os (GPIOs)	Maximum 48 GPIOs
HPS DDR Shared I/Os	3X 48 - May be assigned to HPS for HPS DDR access
Direct I/Os	48 I/Os to connect HPS peripherals directly to I/O
Watchdog timers	4X
Security	Secure device manager, Advanced Encryption Standard (AES) AES-256/SHA-256 bitstream encryption/authentication, PUF, ECDSA 256/384 boot code authentication, side-channel attack protection

Notes:

1. With overdrive feature.



# Intel Stratix 10 MX FPGA Features

Product Line		MX 1650	MX 1650	
Resources	Logic elements (LEs) <sup>1</sup>	1,679,000	1,679,000	
	Adaptive logic modules (ALMs)	569,200	569,200	
	ALM registers	2,276,800	2,276,800	
	Hyper-Registers from Intel Hyperflex FPGA Architecture			
	Programmable clock trees synthesizable			
	HBM2 high-bandwidth DRAM memory (GB)	8	16	
	eSRAM memory blocks	2	2	
	eSRAM memory size (Mb)	94.5	94.5	
	M20K memory blocks	6,162	6,162	
	M20K memory size (Mb)	120	120	
	MLAB memory size (Mb)	9	9	
	Variable-precision digital signal processing (DSP) blocks	3,326	3,326	
	18 x 19 multipliers	6,652	6,652	
	Peak fixed-point performance (TMACS) <sup>2</sup>	13.3	13.3	
	Peak floating-point performance (TFLOPS) <sup>3</sup>	5.3	5.3	
I/O and Architectural Features	Secure device manager		AES-256/SHA-256 bitstream	
	Hard processor system <sup>4</sup>	–	–	
	Maximum user I/O pins	656	656	
	LVDS pairs 1.6 Gbps (RX or TX)	312	312	
	Total full duplex transceiver count	96	96	
	GXE transceiver count - PAM4 (up to 57.8 Gbps) or NRZ (up to 28.9 Gbps)	0	0	
	GXT transceiver count - NRZ (up to 28.3 Gbps)	64	64	
	GX transceiver count - NRZ (up to 17.4 Gbps)	32	32	
	PCI Express hard intellectual property (IP) blocks (3.0 x16)	4	4	
	100G Ethernet MAC (no FEC) hard IP blocks	4	4	
	100G Ethernet MAC + FEC hard IP blocks	0	0	
Memory devices supported				
<b>Package Options and I/O Pins: General-Purpose I/O (GPIO) Count, High-Voltage I/O Count, LVDS Pairs, E-Tile Transceiver Count and H-Tile Transceiver Count<sup>5,6</sup></b>				
F2597 pin (52.5 mm x 52.5 mm, 1.0mm pitch)	656, 32, 312, 0, 96	656, 32, 312, 0, 96		
F2912 pin (55 mm x 55 mm, 1.0 mm pitch)	–	–		58

Notes:

1. LE counts valid in comparing across Intel FPGAs, and are conservative vs. competing FPGAs.
2. Fixed point performance assumes the use of pre-adder.
3. Floating-point performance is IEEE-754 compliant single-precision.
4. Quad-core Arm Cortex-A53 hard processor system not available in Intel Stratix 10 MX devices.
5. A subset of pins for each package are used for high-voltage 3.0 V and 2.5 V interfaces.
6. All data is preliminary and subject to change without prior notice.

656,32,312,0,96 Numbers indicate total GPIO count, high-voltage I/O count, LVDS pairs, E-Tile transceiver count and H-Tile transceiver count.

Indicates pin migration path.

View device ordering codes on [page 56](#).

MX 1650	MX 2100	MX 2100	MX 2100	MX 2100
1,679,000	2,073,000	2,073,000	2,073,000	2,073,000
569,200	702,720	702,720	702,720	702,720
2,276,800	2,810,880	2,810,880	2,810,880	2,810,880

Millions of Hyper-Registers distributed throughout the monolithic FPGA fabric

Hundreds of synthesizable clock trees				
8	8	8	16	8
2	2	2	2	2
94.5	94.5	94.5	94.5	94.5
6,162	6,847	6,847	6,847	6,847
120	134	134	134	134
9	11	11	11	11
3,326	3,960	3,960	3,960	3,960
6,652	7,920	7,920	7,920	7,920
13.3	15.8	15.8	15.8	15.8
5.3	6.3	6.3	6.3	6.3

m encryption/authentication, physically unclonable function (PUF), ECDSA 256/384 boot code authentication, side-channel attack protection

-	-	-	-	-
584	640	656	656	584
288	312	312	312	288
96	48	96	96	96
36 PAM-4 72 NRZ	0	0	0	36 PAM-4 72 NRZ
16	32	64	64	16
8	16	32	32	8
1	2	4	4	1
1	2	4	4	1
12	0	0	0	12

DDR4, DDR3, DDR2, DDR, QDR II, QDR II+, RLD RAM II, RLD RAM 3, HMC, MoSys

-	640, 16, 312, 0, 48	656, 32, 312, 0, 96	656, 32, 312, 0, 96	-
4, 8, 288, 72, 24	-	-	-	584, 8, 288, 72, 24

# Intel Stratix 10 DX FPGA Features

Product Line		DX 1100	DX 2100	
Resources	Logic elements (LEs) <sup>1</sup>	1,325,000	2,073,000	
	Adaptive logic modules (ALMs)	449,280	702,720	
	ALM registers	1,797,120	2,810,880	
	Hyper-Registers from Intel Hyperflex FPGA Architecture	Millions of Hyper-Registers distributed throughout device		
	Programmable clock trees synthesizable	Hundreds of synthesizable clock trees		
	HBM2 High-bandwidth DRAM memory stacks	–	2	
	HBM2 High-bandwidth DRAM memory size (GB)	–	8	
	eSRAM memory blocks	–	2	
	eSRAM memory size (Mb)	–	94.3	
	M20K memory blocks	5,461	6,848	
	M20K memory size (Mb)	107	134	
	MLAB memory size (Mb)	7	11	
	Variable-precision digital signal processing (DSP) blocks	2,592	3,968	
	18 x 19 multipliers	5,184	7,928	
	Peak fixed-point performance (TMACS) <sup>2</sup>	10.4	15.8	
Peak floating-point performance (TFLOPS) <sup>3</sup>	4.1	6.3		
I/O and Architectural Features	Secure device manager	AES-256/SHA-256 bitstream encryption/authentication, physically unclonable function, side-channel attack mitigation		
	Hard processor system <sup>4</sup>	Quad-core 64-bit Arm Cortex-A53 up to 1.5 GHz with 32KB I/D cache, NEON coprocessor, cache coherency unit, hard memory controllers, USB 2.0 x2, 1G EMAC x3		
		Yes	–	
	Maximum user I/O pins	528	612	
	Maximum LVDS pairs 1.6 Gbps (RX or TX)	264	306	
	Total full duplex transceiver count - non return to zero (NRZ)	32	84	
	GXE transceiver count - PAM4 (up to 57.8 Gbps) or NRZ (up to 28.9 Gbps)	8 PAM-4, or 16 NRZ	12 PAM-4, or 24 NRZ	
	GXP transceiver count - NRZ (up to 16 Gbps)	16	60	
	UPI/PCI Express 4.0 x16 hard intellectual property (IP) blocks (configurable for UPI or PCIe operation)	–	3	
	PCI Express 4.0 x16 hard IP blocks (supports PCIe only)	1	–	
100G Ethernet media access control (MAC) + forward error correction (FEC) hard IP blocks	4	4		
Memory devices supported	DDR4, DDR3, DDR2, DDR, QDR II, QDR III			
<b>Package Options and I/O Pins: General-Purpose I/O (GPIO) Count, High-Voltage I/O Count, LVDS Pairs, P-Tile Transceiver Count and E-Tile Transceiver Count</b>				
F1760 pin (42.5 mm x 42.5 mm, 1.0 mm pitch)	528,0,264,16,16	–	–	
F2597 pin (52.5 mm x 52.5 mm, 1.0 mm pitch)	–	–	612,0,306,16,16	
F2912 pin (55 mm x 55 mm, 1.0 mm pitch)	–	–	–	

- Notes:
1. LE counts valid in comparing across Intel FPGAs, and are conservative vs. competing FPGAs.
  2. Fixed-point performance assumes the use of pre-adder.
  3. Floating-point performance is IEEE-754 compliant single-precision.
  4. Quad-core Arm Cortex-A53 hard processor system present in select Intel Stratix 10 DX devices.
  5. All data is preliminary and subject to change without prior notice.

816,0,408,76,8 Numbers indicate total GPIO count, high-voltage I/O count, LVDS pairs, P-Tile transceiver count, E-Tile transceiver count.

View device ordering codes on [page 57](#).

	DX 2800
00	2,753,000
20	933,120
880	3,732,480
throughout the monolithic FPGA fabric	
scalable clock trees	
	–
	–
	–
5	–
7	11,721
4	229
	15
0	5,760
0	11,520
3	23.0
	9.2
programmable function (PUF), ECDSA 256/384 boot code authentication, clock protection	
processor, 1 MB L2 cache, direct memory access (DMA), system memory management	
3, UART x2, SPI x4, I2C x5, general purpose timers x7, watchdog timer x4	
	–
2	816
5	408
	84
or 24 NRZ	4 PAM-4, or 8 NRZ
	76
	3
	1
	2
DDR II+, RDRAM II, RDRAM 3	
	–
6,60,24	–
	816,0,408,76,8

Product Line	Hard Processor System (HPS)
Processor	Quad-core 64 bit Arm Cortex-A53 MPCore processor
Maximum processor frequency	1.5 GHz <sup>1</sup>
Processor cache and co-processors	<ul style="list-style-type: none"> <li>• L1 instruction cache (32 KB)</li> <li>• L1 data cache (32 KB) with error correction code (ECC)</li> <li>• Level 2 cache (1 MB) with ECC</li> <li>• Floating-point unit (FPU) single and double precision</li> <li>• Arm NEON media engine</li> <li>• Arm CoreSight debug and trace technology</li> <li>• System Memory Management Unit (SMMU)</li> <li>• Cache Coherency Unit (CCU)</li> </ul>
Scratch pad RAM	256 KB
HPS DDR memory	DDR4, DDR3 (Up to 64 bit with ECC)
DMA controller	8 channels
EMAC	3X 10/100/1000 Ethernet media access controller (EMAC) with integrated DMA
USB On-The-Go (OTG) controller	2X USB OTG with integrated DMA
UART controller	2X UART 16550 compatible
Serial peripheral interface (SPI) controller	4X SPI
I <sup>2</sup> C controller	5X I <sup>2</sup> C
Quad SPI flash controller	1X SIO, DIO, QIO SPI flash supported
SD/SDIO/MMC controller	1X eMMC 4.5 with DMA and CE-ATA support
NAND flash controller	<ul style="list-style-type: none"> <li>• 1X ONFI 1.0 or later</li> <li>• 8 and 16 bit support</li> </ul>
General-purpose timers	4X
Software-programmable general-purpose I/Os (GPIOs)	Maximum 48 GPIOs
HPS DDR Shared I/Os	3X 48 - May be assigned to HPS for HPS DDR access
Direct I/Os	48 I/Os to connect HPS peripherals directly to I/O
Watchdog timers	4X
Security	Secure device manager, Advanced Encryption Standard (AES) AES-256/SHA-256 bitstream encryption/authentication, PUF, ECDSA 256/384 boot code authentication, side-channel attack protection

Notes:

1. With overdrive feature.

# Intel Stratix 10 SX SoC Features

Product Line		SX 400	SX 650	SX 850	SX 1100
Resources	Logic elements (LEs) <sup>1</sup>	378,000	612,000	841,000	1,325,000
	Adaptive logic modules (ALMs)	128,160	207,360	284,960	449,280
	ALM registers	512,640	829,440	1,139,840	1,797,120
	Hyper-Registers from Intel Hyperflex FPGA Architecture	Millions of Hyper-Registers distributed			
	Programmable clock trees synthesizable	Hundreds of synthesizable			
	M20K memory blocks	1,537	2,489	3,477	5,461
	M20K memory size (Mb)	30	49	68	107
	MLAB memory size (Mb)	2	3	4	7
	Variable-precision digital signal processing (DSP) blocks	648	1,152	2,016	2,592
	18 x 19 multipliers	1,296	2,304	4,032	5,184
	Peak fixed-point performance (TMACS) <sup>2</sup>	2.6	4.6	8.1	10.4
	Peak floating-point performance (TFLOPS) <sup>3</sup>	1.0	1.8	3.2	4.1
	I/O and Architectural Features	Secure device manager	AES-256/SHA-256 bitstream encryption/authentication, physically unclonable function, side-channel attack mitigation		
Hard processor system <sup>4</sup>		Quad-core 64-bit Arm Cortex-A53 up to 1.5 GHz with 32KB I/D cache, NEON SIMD, cache management unit, cache coherency unit, hard memory controllers, USB 2.0 x2, 10GbE			
Maximum user I/O pins		374	392	688	688
Maximum LVDS pairs 1.6 Gbps (RX or TX)		120	192	336	336
Total full duplex transceiver count		24	24	48	48
GXT full duplex transceiver count (up to 28.3 Gbps)		16	16	32	32
GX full duplex transceiver count (up to 17.4 Gbps)		8	8	16	16
PCI Express hard intellectual property (IP) blocks (3.0 x16)		1	1	2	2
Memory devices supported	DDR4, DDR3, DDR2, DDR, QDR II				

### Package Options and I/O Pins: General-Purpose I/O (GPIO) Count, High-Voltage I/O Count, LVDS Pairs, and Transceiver Count<sup>5,6</sup>

F1152 pin (35 mm x 35 mm, 1.0 mm pitch)	374,56,120,24	392,8,192,24	–	–
F1760 pin (42.5 mm x 42.5 mm, 1.0 mm pitch)	–	–	688,16,336,48	688,16,336,48
F2397 pin (50 mm x 50 mm, 1.0 mm pitch)	–	–	–	–
F2912 pin (55 mm x 55 mm, 1.0 mm pitch)	–	–	–	–

Notes:

- LE counts valid in comparing across Intel FPGAs, and are conservative vs. competing FPGAs.
- Fixed point performance assumes the use of pre-adder.
- Floating point performance is IEEE-754 compliant single-precision.
- Quad-core Arm Cortex-A53 hard processor system only available in Intel Stratix 10 SX SoCs.
- A subset of pins for each package are used for high-voltage 3.0 V and 2.5 V interfaces.
- All data is preliminary and subject to change without prior notice.

392,8,192,24 Numbers indicate total GPIO count, high-voltage I/O count, LVDS pairs, and transceiver count.

Indicates pin migration path.

View device ordering codes on [page 56](#).

SX 1650	SX 2100	SX 2500	SX 2800
1,624,000	2,005,000	2,422,000	2,753,000
550,540	679,680	821,150	933,120
2,202,160	2,718,720	3,284,600	3,732,480

distributed throughout the monolithic FPGA fabric

resizable clock trees

5,851	6,501	9,963	11,721
114	127	195	229
8	11	13	15
3,145	3,744	5,011	5,760
6,290	7,488	10,022	11,520
12.6	15.0	20.0	23.0
5.0	6.0	8.0	9.2

unclonable function (PUF), ECDSA 256/384 boot code authentication, attack protection

processor, 1 MB L2 cache, direct memory access (DMA), system memory, 3x EMAC x3, UART x2, SPI x4, I2C x5, general purpose timers x7, watchdog timer x4

704	704	1160	1160
336	336	576	576
96	96	96	96
64	64	64	64
32	32	32	32
4	4	4	4

QDR II+, RLDRAM II, RLDRAM 3, HMC, MoSys

-	-	-	-
688,16,336,48	688,16,336,48	688,16,336,48	688,16,336,48
704,32,336,96	704,32,336,96	704,32,336,96	704,32,336,96
-	-	1160,8,576,24	1160,8,576,24

Product Line	Hard Processor System (HPS)
Processor	Quad-core 64 bit Arm Cortex-A53 MPCore processor
Maximum processor frequency	1.5 GHz <sup>1</sup>
Processor cache and co-processors	<ul style="list-style-type: none"> <li>L1 instruction cache (32 KB)</li> <li>L1 data cache (32 KB) with error correction code (ECC)</li> <li>Level 2 cache (1 MB) with ECC</li> <li>Floating-point unit (FPU) single and double precision</li> <li>Arm NEON media engine</li> <li>Arm CoreSight debug and trace technology</li> <li>System Memory Management Unit (SMMU)</li> <li>Cache Coherency Unit (CCU)</li> </ul>
Scratch pad RAM	256 KB
HPS DDR memory	DDR4 and DDR3 (Up to 64 bit with ECC)
Direct memory access (DMA) controller	8 channels
EMAC	3X 10/100/1000 Ethernet media access controller (EMAC) with integrated DMA
USB On-The-Go (OTG) controller	2X USB OTG with integrated DMA
UART controller	2X UART 16550 compatible
Serial peripheral interface (SPI) controller	4X SPI
I <sup>2</sup> C controller	5X I <sup>2</sup> C
Quad SPI flash controller	1X SIO, DIO, QIO SPI flash supported
SD/SDIO/MMC controller	1X eMMC 4.5 with DMA and CE-ATA support
NAND flash controller	<ul style="list-style-type: none"> <li>1X ONFI 1.0 or later</li> <li>8 and 16 bit support</li> </ul>
General-purpose timers	4X
Software-programmable general-purpose I/Os (GPIOs)	Maximum 48 GPIOs
HPS DDR Shared I/O	3X 48 - May be assigned to HPS for HPS DDR access
Direct I/Os	48 I/Os to connect HPS peripherals directly to I/O
Watchdog timers	4X
Security	Secure device manager, Advanced Encryption Standard (AES) AES-256/SHA-256 bitstream encryption/authentication, PUF, ECDSA 256/384 boot code authentication, side-channel attack protection

Notes:

1. With overdrive feature.

# Accelerator Cards That Fit Your Performance Needs

Intel® FPGA-based acceleration solutions make it possible to move, process, and store data faster and more efficiently. Intel and partner Programmable Acceleration Cards (PACs), Infrastructure Processing Units (IPUs), and SmartNICs offer hardware programmability on production-qualified cards, which enable the quick design and deployment of workloads in networking, wireless, cloud, and data center applications.



**Silicom FPGA  
SmartNIC N5010**

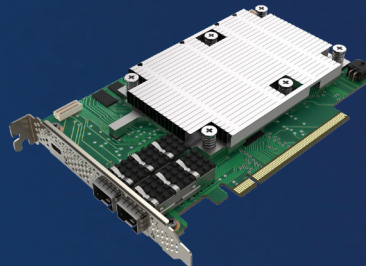

**Inventec FPGA  
IPU C5020X**

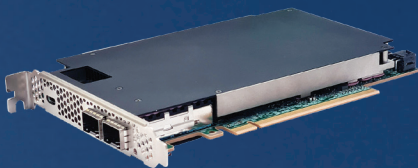

**Silicom FPGA IPU  
C5010X**



**Silicom FPGA SmartNIC  
N6010**



**WNC FPGA SmartNIC  
WSN6050**

For more information, please visit:

[intel.com/content/www/us/en/products/details/fpga/platforms/pac.html](https://www.intel.com/content/www/us/en/products/details/fpga/platforms/pac.html)

# Intel Arria 10 FPGA and SoC Overview

[intel.com/arria10](http://intel.com/arria10)

Intel Arria 10 FPGAs and SoCs deliver the highest performance at 20 nm, offering a one speed-grade performance advantage over competing devices. Intel Arria 10 FPGAs and SoCs are up to 40% lower power than previous generation FPGAs and SoCs, and feature the industry's only hard floating-point DSP blocks with speeds up to 1,500 giga floating-point operations per second (GFLOPS)<sup>†</sup>. The Intel Arria 10 FPGAs and SoCs are ideal for the following end market applications.

## Wireless



### Applications

- Remote radio head
- Mobile backhaul
- Active antenna
- Base station
- 4G/Long Term Evolution (LTE) macro eNB
- Wideband Code Division Multiple Access (W-CDMA)

## Cloud Service and Storage

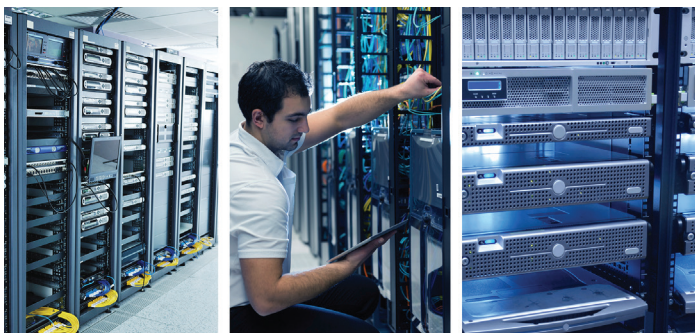

### Applications

- Flash cache
- Cloud
- Server
- Financial
- Bioscience
- Oil and gas
- Data center server acceleration

## Broadcast



### Applications

- Switcher
- Server
- Encoder/decoder
- Capture cards
- Editing
- Monitors
- Multiviewers



# Intel Arria 10 FPGA Features

Product Line		GX 160	GX 220	GX 270	GX 320
Resources	Part number reference	10AX016	10AX022	10AX027	10AX032
	LEs (K)	160	220	270	320
	System logic elements (K)	210	288	354	419
	Adaptive logic modules (ALMs)	61,510	83,730	101,620	118,730
	Registers	246,040	334,920	406,480	474,920
	M20K memory blocks	440	588	750	891
	M20K memory (Mb)	9	11	15	17
	MLAB memory (Mb)	1.0	1.8	2.4	2.8
	Hardened single-precision floating-point multipliers/ adders	156/156	191/191	830/830	985/985
	18 x 19 multipliers	312	382	1,660	1,970
	Peak fixed-point performance (GMACS) <sup>1</sup>	343	420	1,826	2,167
	Peak floating-point performance (GFLOPS)	140	172	747	887
	Clocks, Maximum I/O Pins, and Architectural Features	Global clock networks	32	32	32
Regional clocks		8	8	8	8
I/O voltage levels supported (V)					
I/O standards supported					DDR and LVDS I/O pins: All I/Os: 1.8 V CMOS, 1.5 V CMOS, 1.2 V CMOS, SSTL-135, SSTL-125, Differential SSTL-18 (I and II), Differential SSTL-15 (I and II),
Maximum LVDS channels (1.6 G)		120	120	168	168
Maximum user I/O pins		288	288	384	384
Transceiver count (17.4 Gbps)		12	12	24	24
Transceiver count (25.78 Gbps)		–	–	–	–
PCI Express hardened IP blocks (3.0 x8)		1	1	2	2
Maximum 3 V I/O pins		48	48	48	48
Memory devices supported				DDR4, DDR3,	

## Package Options<sup>2</sup> and I/O Pins<sup>3</sup>: General-Purpose I/O (GPIO) Count, High-Voltage I/O Count, LVDS Pairs<sup>4</sup>, and Transceiver Count

U19	U484 pin (19 mm)	192, 48, 72, 6	192, 48, 72, 6	–	–
F27	F672 pin (27 mm)	240, 48, 96, 12	240, 48, 96, 12	240, 48, 96, 12	240, 48, 96, 12
F29	F780 pin (29 mm)	288, 48, 120, 12	288, 48, 120, 12	360, 48, 156, 12	360, 48, 156, 12
F34	F1152 pin (35 mm)	–	–	384, 48, 168, 24	384, 48, 168, 24
F35	F1152 pin (35 mm)	–	–	384, 48, 168, 24	384, 48, 168, 24
KF40	F1517 pin (40 mm)	–	–	–	–
NF40	F1517 pin (40 mm)	–	–	–	–
RF40	F1517 pin (40 mm)	–	–	–	–
NF45	F1932 pin (45 mm)	–	–	–	–
SF45	F1932 pin (45 mm)	–	–	–	–
UF45	F1932 pin (45 mm)	–	–	–	–

Notes:

- Fixed-point performance assumes the use of pre-adders.
- All packages are ball grid arrays with 1.0 mm pitch, except for U19 (U484), which is 0.8 mm pitch.
- A subset of pins for each package are used for 3.3 V and 2.5 V interfaces.
- Each LVDS pair can be configured as either a differential input or a differential output.
- Certain packages might not bond out all PCI Express hard IP blocks.

- All data is correct at the time of printing, and may be subject to change without prior notice. For the latest information, please visit [www.intel.com/fpga](http://www.intel.com/fpga).

**192, 48, 72, 6** Numbers indicate GPIO count, high-voltage I/O count, LVDS pairs, and transceiver count.

 Indicates pin migration.

View device ordering codes on [page 57](#).

GX 480	GX 570	GX 660	GX 900	GX 1150	GT 900	GT 1150
10AX048	10AX057	10AX066	10AX090	10AX115	10AT090	10AT115
480	570	660	900	1,150	900	1,150
629	747	865	1,180	1,506	1,180	1,506
181,790	217,080	250,540	339,620	427,200	339,620	427,200
727,160	868,320	1,002,160	1,358,480	1,708,800	1,358,480	1,708,800
1,438	1,800	2,133	2,423	2,713	2,423	2,713
28	35	42	47	53	47	53
4.3	5.0	5.7	9.2	12.7	9.2	12.7
1,368/1,368	1,523/1,523	1,688/1,688	1,518/1,518	1,518/1,518	1,518/1,518	1,518/1,518
2,736	3,046	3,376	3,036	3,036	3,036	3,036
3,010	3,351	3,714	3,340	3,340	3,340	3,340
1,231	1,371	1,519	1,366	1,366	1,366	1,366
32	32	32	32	32	32	32
8	8	16	16	16	16	16

1.2, 1.25, 1.35, 1.8, 2.5, 3.0

3 V I/O pins only: 3 V LVTTTL, 2.5 V CMOS

POD12, POD10, Differential POD12, Differential POD10, LVDS, RSDS, mini-LVDS, LVPECL

SSTL-18 (I and II), SSTL-15 (I and II), SSTL-12, HSTL-18 (I and II), HSTL-15 (I and II), HSTL-12 (I and II), HSUL-12, Differential SSTL-135, Differential SSTL-125, Differential SSTL-12, Differential HSTL-18 (I and II), Differential HSTL-15 (I and II), Differential HSTL-12 (I and II), Differential HSUL-12

222	324	270	384	384	312	312
492	696	696	768	768	624	624
36	48	48	96	96	72	72
-	-	-	-	-	6	6
2	2	2	4	4	4	4
48	48	48	-	-	-	-

DDR2, QDR IV, QDR II+, QDR II+ Xtreme, LPDDR3, LPDDR2, RDRAM 3, RDRAM II, LDRAM II, HMC

-	-	-	-	-	-	-
-	-	-	-	-	-	-
360, 48, 156, 12	-	-	-	-	-	-
492, 48, 222, 24	492, 48, 222, 24	492, 48, 222, 24	504, 0, 252, 24	504, 0, 252, 24	-	-
396, 48, 174, 36	396, 48, 174, 36	396, 48, 174, 36	-	-	-	-
-	696, 96, 324, 36	696, 96, 324, 36	-	-	-	-
-	588, 48, 270, 48	588, 48, 270, 48	600, 0, 300, 48	600, 0, 300, 48	-	-
-	-	-	342, 0, 154, 66	342, 0, 154, 66	-	-
-	-	-	768, 0, 384, 48	768, 0, 384, 48	-	-
-	-	-	624, 0, 312, 72	624, 0, 312, 72	624, 0, 312, 72	624, 0, 312, 72
-	-	-	480, 0, 240, 96	480, 0, 240, 96	-	-

# Intel Arria 10 SoC Features

Product Line		SX 160	SX 220	SX 270	SX 320
Resources	Part number reference	10AS016	10AS022	10AS027	10AS032
	LEs (K)	160	220	270	320
	System Logic Elements (K)	210	288	354	419
	ALMs	61,510	83,730	101,620	118,730
	Registers	246,040	334,920	406,480	474,920
	M20K memory blocks	440	588	750	891
	M20K memory (Mb)	9	11	15	17
	MLAB memory (Mb)	1.0	1.8	2.4	2.8
	Hardened single-precision floating-point multipliers/ adders	156/156	191/191	830/830	985/985
	18 x 19 multipliers	312	382	1,660	1,970
	Peak fixed-point performance (GMACS) <sup>1</sup>	343	420	1,826	2,167
	Peak floating-point performance (GFLOPS)	140	172	747	887
	Clocks, Maximum I/O Pins, and Architectural Features	Global clock networks	32	32	32
Regional clocks		8	8	8	8
I/O voltage levels supported (V)		1.2, 1.25, 1.35, 1.8, 3 V I/O pins only: 3 V LVTTTL, DDR and LVDS I/O pins: POD12, POD10, Differential POD12, Differential			
I/O standards supported		All I/Os: 1.8 V CMOS, 1.5 V CMOS, 1.2 V CMOS, SSTL-135, SSTL-125, SSTL-18 HSTL-15 (I and II), HSTL-12 (I and II), HSUL-12, Differential SSTL-135, Differential SSTL-15 (I and II), Differential SSTL-12, Differential HSTL-18 (I and II), Differential Differential HSUL-12			
Maximum LVDS channels (1.6 G)		120	120	168	168
Maximum user I/O pins		288	288	384	384
Transceiver count (17.4 Gbps)		12	12	24	24
Transceiver count (25.78 Gbps)		–	–	–	–
PCI Express hardened IP blocks (3.0 x8)		1	1	2	2
Maximum 3 V I/O pins		48	48	48	48
Memory devices supported	DDR4, DDR3, DDR2, QDR IV, QDR II+, QDR II+ Xtreme, LPDDR3, LP				
<b>Package Options<sup>2</sup> and I/O Pins<sup>3</sup>: General-Purpose I/O (GPIO) Count, High-Voltage I/O Count, LVDS Pairs<sup>4</sup>, and Transceiver Count</b>					
U19	U484 pin (19 mm)	192, 48, 72, 6	192, 48, 72, 6	–	–
F27	F672 pin (27 mm)	240, 48, 96, 12	240, 48, 96, 12	240, 48, 96, 12	240, 48, 96, 12
F29	F780 pin (29 mm)	288, 48, 120, 12	288, 48, 120, 12	360, 48, 156, 12	360, 48, 156, 12
F34	F1152 pin (35 mm)	–	–	384, 48, 168, 24	384, 48, 168, 24
F35	F1152 pin (35 mm)	–	–	384, 48, 168, 24	384, 48, 168, 24
KF40	F1517 pin (40 mm)	–	–	–	–
NF40	F1517 pin (40 mm)	–	–	–	–

- Notes:
- Fixed-point performance assumes the use of pre-adders.
  - All packages are ball grid arrays with 1.0 mm pitch, except for U19 (U484), which is 0.8 mm pitch.
  - A subset of pins for each package are used for 3.3 V and 2.5 V interfaces.
  - Each LVDS pair can be configured as either a differential input or a differential output.
  - Certain packages might not bond out all PCI Express hard IP blocks.
  - All data is correct at the time of printing, and may be subject to change without prior notice. For the latest information, please visit [www.intel.com/fpga](http://www.intel.com/fpga).

192, 48, 72, 6 Numbers indicate GPIO count, high-voltage I/O count, LVDS pairs, and transceiver count.  
 Indicates pin migration.

View device ordering codes on [page 57](#).

SX 480	SX 570	SX 660
10AS048	10AS057	10AS066
480	570	660
629	747	865
181,790	217,080	250,540
727,160	868,320	1,002,160
1,438	1,800	2,133
28	35	42
4.3	5.0	5.7
1,368/1,368	1,523/1,523	1,688/1,688
2,736	3,046	3,376
3,010	3,351	3,714
1,231	1,371	1,519
32	32	32
8	8	16

2.5, 3.0

2.5 V CMOS

POD10, LVDS, RSDS, mini-LVDS, LVPECL

(1 and II), SSTL-15 (I and II), SSTL-12, HSTL-18 (I and II), SSTL-125, Differential SSTL-18 (I and II), Differential HSTL-15 (I and II), Differential HSTL-12 (I and II),

222	270	270
492	696	696
36	48	48
–	–	–
2	2	2
48	48	48

DDR2, RLD RAM 3, RLD RAM II, LLD RAM II, HMC

–	–	–
–	–	–
360, 48, 156, 12	–	–
492, 48, 222, 24	492, 48, 222, 24	492, 48, 222, 24
396, 48, 174, 36	396, 48, 174, 36	396, 48, 174, 36
–	696, 96, 324, 36	696, 96, 324, 36
–	588, 48, 270, 48	588, 48, 270, 48

Product Line	Hard Processor System (HPS)
Processor	Dual-core Arm Cortex-A9 MPCore processor
Maximum processor frequency	1.2 -1.5 GHz <sup>1</sup>
Processor cache and co-processors	<ul style="list-style-type: none"> <li>L1 instruction cache (32 KB)</li> <li>L1 data cache (32 KB)</li> <li>Level 2 cache (512 KB) shared</li> <li>FPU single and double precision</li> <li>Arm Neon media engine</li> <li>Arm CoreSight debug and trace technology</li> <li>Snoop control unit (SCU)</li> <li>Acceleration coherency port (ACP)</li> </ul>
Scratch pad RAM	256 KB
HPS DDR memory	DDR4 and DDR3 (Up to 64 bit with ECC)
DMA controller	8 channels
EMAC	3X 10/100/1000 EMAC with integrated DMA
USB OTG controller	2X USB OTG with integrated DMA
UART controller	2X UART 16550 compatible
SPI controller	4X SPI
I <sup>2</sup> C controller	5X I <sup>2</sup> C
Quad SPI flash controller	1X SIO, DIO, QIO SPI flash supported
SD/SDIO/MMC controller	1X eMMC 4.5 with DMA and CE-ATA support
NAND flash controller	<ul style="list-style-type: none"> <li>1X ONFI 1.0 or later</li> <li>8 and 16 bit support</li> </ul>
General-purpose timers	7X
Software-programmable GPIOs	Maximum 54 GPIOs
Direct shared I/Os	48 I/Os to connect HPS peripherals directly to I/O
Watchdog timers	4X
Security	Secure boot, AES, and secure hash algorithm

Notes:

1. With overdrive feature.

# Intel Cyclone 10 FPGA Overview

[intel.com/cyclone10](http://intel.com/cyclone10)

Intel Cyclone 10 FPGAs deliver cost and power savings over previous generations of Intel Cyclone FPGAs. Intel Cyclone 10 GX FPGAs provide high bandwidth via 12.5G transceiver-based functions, 1.4 Gbps LVDS, and 1,866 Mbps DDR3 SDRAM, and feature a hard floating-point DSP block in a low-cost FPGA. Intel Cyclone 10 LP devices offer low static power, cost-optimized functions.

- Intel Cyclone 10 GX FPGAs are optimized for high bandwidth<sup>†</sup>
- Intel Cyclone 10 LP FPGAs are optimized for power and cost-sensitive applications

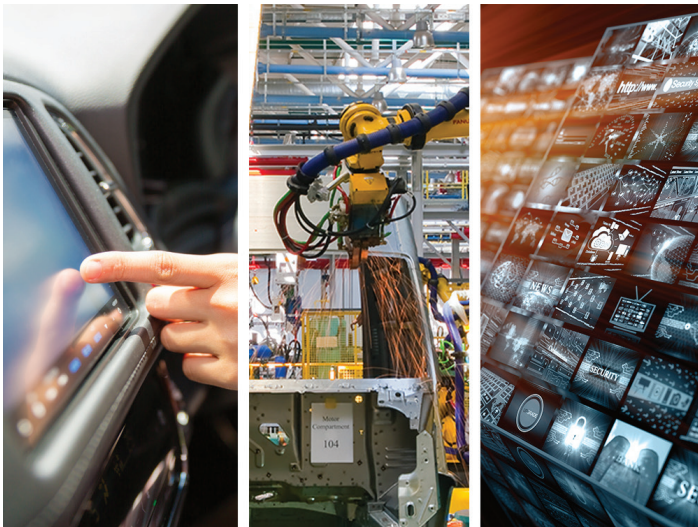

## Intel Cyclone 10 GX FPGA

- Low-cost 12.5 Gbps transceivers
- 1,866 Mbps 72 bit DDR3 SDRAM interface
- 1.4 Gbps LVDS
- The industry's first low-cost FPGA with hard floating-point blocks

### GX Applications

- Embedded vision cameras
- Industrial robotics
- Machine vision
- Programmable logic controllers
- Pro-AV systems

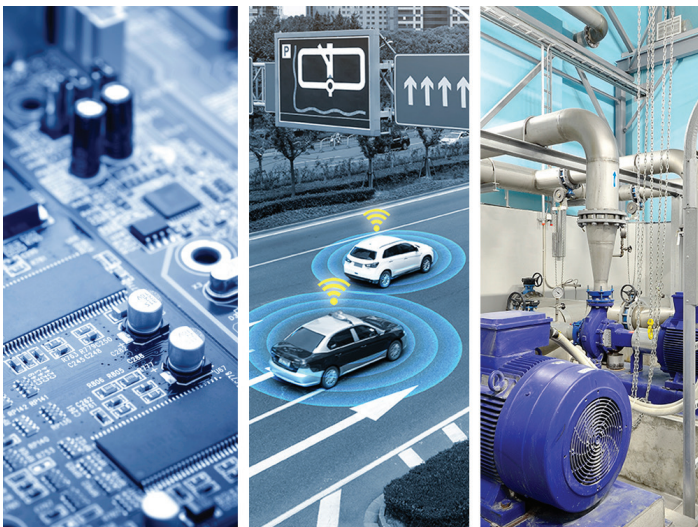

## Intel Cyclone 10 LP FPGA

- Designed for power-sensitive applications
- Simplified core power supply requirements
- High I/O count to package density ratio
- Embedded Nios II soft processor support

### LP Applications

- I/O expansion
- Interfacing
- Chip-to-chip bridging
- Sensor fusion
- Industrial motor control

<sup>†</sup> Compared to previous generation Cyclone FPGAs, cost comparisons are based on list price. Tests measure performance of components on a particular test, in specific systems. Differences in hardware, software, or configuration will affect actual performance. Consult other sources of information to evaluate performance as you consider your purchase. For more complete information about performance and benchmark results, visit [www.intel.com/benchmarks](http://www.intel.com/benchmarks).

# Intel Cyclone 10 GX FPGA Features

View device ordering codes on [page 58](#).

Product Line	10CX085	10CX105	10CX150	10CX220	
Resources	Logic elements (LEs) <sup>1</sup>	85,000	104,000	150,000	220,000
	Adaptive logic modules (ALMs)	31,000	38,000	54,770	80,330
	ALM registers	124,000	152,000	219,080	321,320
	M20K memory blocks	291	382	475	587
	M20K memory size (Kb)	5,820	7,640	9,500	11,740
	MLAB memory size (Kb)	653	799	1,152	1,690
	Variable-precision digital signal processing (DSP) blocks	84	125	156	192
	18 x 19 multipliers	168	250	312	384
	Peak fixed-point performance (GMACS) <sup>2</sup>	151	225	281	346
	Peak floating-point performance (GFLOPS) <sup>3</sup>	59	88	109	134
I/O and Architectural Features	Global clock networks	32	32	32	32
	Regional clocks	8	8	8	8
	Maximum user I/O pins	192	284	284	284
	Maximum LVDS pairs 1.4 Gbps (RX or TX)	72	118	118	118
	Maximum transceiver count (12.5 Gbps)	6	12	12	12
	Maximum 3V I/O pins	48	48	48	48
	PCI Express hard IP blocks (2.0 x4) <sup>4</sup>	1	1	1	1
	Memory devices supported	DDR3, DDR3L, LPDDR3			

## Package Options and I/O Pins: General-Purpose I/O (GPIO) Count, 3V I/O Count, LVDS Pairs, Total Transceiver count<sup>5</sup>

U484 pin (19 mm x 19 mm, 0.8 mm pitch)	188, 48, 70, 6	188, 48, 70, 6	188, 48, 70, 6	188, 48, 70, 6
F672 pin (27 mm x 27 mm, 1.0 mm pitch)	192, 48, 72, 6	236, 48, 94, 10	236, 48, 94, 10	236, 48, 94, 10
F780 pin (29 mm x 29 mm, 1.0 mm pitch)		284, 48, 118, 12	284, 48, 118, 12	284, 48, 118, 12

### Notes:

1. LE counts valid in comparing across Intel FPGAs, and are conservative versus competing FPGAs.
2. Fixed-point performance assumes the use of pre-adders.
3. Floating-point performance is IEEE-754 compliant single-precision.
4. Hard PCI Express IP core x2 in U484 package
5. Each LVDS pair can be configured as either a differential input or differential output.
6. A subset of pins for each package are used for high-voltage 3.0 V and 2.5 V interfaces.
7. All data is correct at the time of printing and may be subject to change without prior notice. For the latest information, please visit [www.intel.com/fpga](http://www.intel.com/fpga).

284,48,118,12 Numbers indicate GPIO count, 3V I/O count, LVDS pairs, total transceiver count.

— Indicates pin migration path.

# Intel Cyclone 10 LP FPGA Features

Product Line		10CL006	10CL010
Resources	Logic elements (LEs) <sup>1</sup>	6,000	10,000
	M9K memory blocks	30	46
	M9K memory size (Kb)	270	414
	DSP blocks (18 x 18 multipliers)	15	23
	Phase-locked loops (PLL)	2	2
I/O and Architectural Features	Global clock networks	10	10
	Maximum user I/O pins	176	176
	Maximum LVDS channels	65	65

## Package Options and I/O Pins: General-Purpose I/O (GPIO) Count, LVDS Pairs<sup>2</sup>

E144 pin (22 mm x 22mm, 0.5 mm pitch)	88, 22	88, 22
M164 pin (8 mm x 8 mm, 0.5 mm pitch)		101, 26
U256 pin (14 mm x 14 mm, 0.8 mm pitch)	176, 65	176, 65
U484 pin (19 mm x 19 mm, 0.8 mm pitch)		
F484 pin (23 mm x 23 mm, 1.0 mm pitch)		
F780 pin (29 mm x 29 mm, 1.0 mm pitch)		

Notes:

1. LE counts valid in comparing across Intel FPGAs, and are conservative versus competing FPGAs.
2. This includes both dedicated and emulated LVDS pairs
3. All data is correct at the time of printing and may be subject to change without prior notice. For the latest information, please visit [www.intel.com/fpga](http://www.intel.com/fpga).

71, 22 Numbers indicate GPIO count, LVDS pairs.

Indicates pin migration path.

View device ordering codes on [page 58](#).

10CL016	10CL025	10CL040	10CL055	10CL080	10CL120
16,000	25,000	40,000	55,000	80,000	120,000
56	66	126	260	305	432
504	594	1,134	2,340	2,745	3,888
56	66	126	156	244	288
4	4	4	4	4	4
20	20	20	20	20	20
340	150	325	321	423	525
137	52	124	132	178	230

78, 19	76, 18				
87, 22					
162, 53	150, 52				
340, 137		325, 124	321, 132	289, 110	
340, 137		325, 124	321, 132	289, 110	277, 103
				423, 178	525, 230



# Intel MAX 10 FPGA Overview

[intel.com/max10](https://intel.com/max10)

Intel MAX 10 FPGAs revolutionize non-volatile integration by delivering advanced processing capabilities in a low-cost, instant-on, small form factor, programmable logic device.

Intel MAX 10 FPGAs are built on TSMC's 55 nm flash technology, enabling instant-on configuration so you can quickly control the power-up or initialization of other components in the system. The devices also include full-featured FPGA capabilities, such as DSP, analog functionality, Nios II Gen2 embedded soft processor support, and memory controllers.

With a robust set of FPGA capabilities, Intel MAX 10 FPGAs are optimized for a wide range of high-volume, cost-sensitive applications, including:

## Automotive



- Built on TSMC's 55 nm high-volume flash process tailored for the automotive industry's rigorous safety and quality requirements
- Integrated flash provides instant-on behavior for applications requiring fast boot times such as rear-view cameras in advanced driver assistance systems (ADAS) and infotainment displays
- FPGA-class signal processing acceleration for electric vehicle (EV) applications, such as motor control, battery management, and power conversion

## Industrial



- Reduced footprint, increased design security and reliability, and lower system cost
- Accurate environmental condition sensing and efficient real-time controls for motor control, I/O modules, and Internet of Things (IoT) applications
- Single-chip support for multiple industrial Ethernet protocols and machine-to-machine (M2M) communication

## Communications

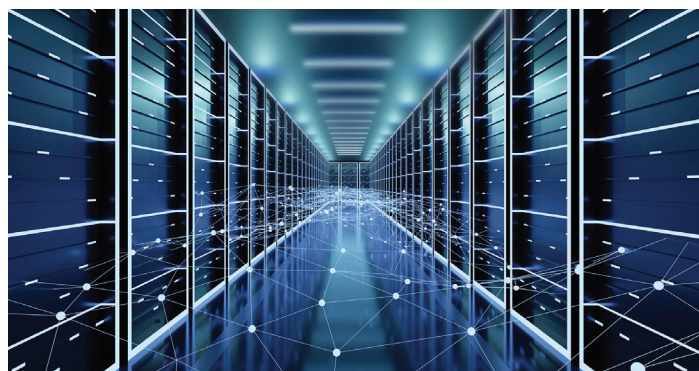

- Analog functionality for sensing board environment allows integration of power-up sequencing and system-monitoring circuitry in a single device
- High I/O count and software-based system management using the Nios II soft processor enable board management integration in an advanced, reliable, single-chip system controller

# Intel MAX 10 FPGA Features

View device ordering codes on [page 58](#).

Product Line	10M02	10M04	10M08	10M16	10M25	10M40	10M50
LEs (K)	2	4	8	16	25	40	50
Block memory (Kb)	108	189	378	549	675	1,260	1,638
User flash memory <sup>1</sup> (KB)	12	16 – 156	32 – 172	32 – 296	32 – 400	64 – 736	64 – 736
18 x 18 multipliers	16	20	24	45	55	125	144
PLLs <sup>2</sup>	1, 2	1, 2	1, 2	1, 4	1, 4	1, 4	1, 4
Internal configuration	Single	Dual	Dual	Dual	Dual	Dual	Dual
Analog-to-digital converter (ADC), temperature sensing diode (TSD) <sup>3</sup>	-	1, 1	1, 1	1, 1	2, 1	2, 1	2, 1
External memory interface (EMIF)	Yes <sup>4</sup>	Yes <sup>4</sup>	Yes <sup>4</sup>	Yes <sup>5</sup>	Yes <sup>5</sup>	Yes <sup>5</sup>	Yes <sup>5</sup>

## Package Options and I/O Pins: Feature Set Options, GPIO, True LVDS Transmitter<sup>9</sup>/Receiver<sup>9</sup>

V36 (D) <sup>6</sup>	WLCSP (3 mm, 0.4 mm pitch)	C, 27, 3/10	-	-	-	-	-	-
V81 (S)	WLCSP (4 mm, 0.4 mm pitch)			L, 58, 7/25				
V81 (D) <sup>7</sup>	WLCSP (4 mm, 0.4 mm pitch)	-	-	C/F, 56, 7/25	-	-	-	-
Y180 (S)	WLCSP (6x5 mm, 0.35 mm pitch)				L, 125, 10/53			
E144 (S) <sup>6</sup>	EQFP (22 mm, 0.5 mm pitch)	C, 101, 7/45	C/A, 101, 10/41	C/A, 101, 10/41	C/A, 101, 10/41	C/A, 101, 10/41	C/A, 101, 10/42	C/A, 101, 10/42
M153 (S)	MBGA (8 mm, 0.5 mm pitch) <sup>8</sup>	C, 112, 9/49	C/A, 112, 9/49	C/A, 112, 9/49	-	-	-	-
U169 (S)	UBGA (11 mm, 0.8 mm pitch)	C, 130, 9/58	C/A, 130, 9/58	C/A, 130, 9/58	C/A, 130, 9/58	-	-	-
U324 (S)	UBGA (15 mm, 0.8 mm pitch)	C, 246, 15/114	C/A, 246, 15/114	C/A, 246, 15/114	C/A, 246, 15/114			
U324 (D)	UBGA (15 mm, 0.8 mm pitch)	C, 160, 9/73	C/A, 246, 15/114	C/A, 246, 15/114	C/A, 246, 15/114	-	-	-
F256 (D)	FBGA (17 mm, 1.0 mm pitch)	-	C/A, 178, 13/80	C/A, 178, 13/80	C/A, 178, 13/80	C/A, 178, 13/80	C/A, 178, 13/80	C/A, 178, 13/80
F484 (D)	FBGA (23 mm, 1.0 mm pitch)	-	-	C/A, 250, 15/116	C/A, 320, 22/151	C/A, 360, 24/171	C/A, 360, 24/171	C/A, 360, 24/171
F672 (D)	FBGA (27 mm, 1.0 mm pitch)	-	-	-	-	-	C/A, 500, 30/241	C/A, 500, 30/241

### Notes:

- Additional user flash may be available, depending on configuration options.
- The number of PLLs available is dependent on the package option.
- Availability of the ADC or TSD varies by package type. Smaller pin-count packages do not have access to the ADC hard IP.
- SRAM only.
- SRAM, DDR3 SDRAM, DDR2 SDRAM, or LPDDR2.
- "D" = Dual power supply (1.2 V/2.5 V), "S" = Single power supply (3.3 V or 3.0 V).
- V81 package does not support analog feature set. 10M08 V81 F devices support dual image with RSU.
- "Easy PCB" utilizes 0.8 mm PCB design rules.
- Some LVDS channels at bottom bank can be configured as TX or RX, refer to the Intel MAX 10 High-Speed LVDS I/O User Guide for details.
- All data is correct at the time of printing, and may be subject to change without prior notice. For the latest information, please visit [www.intel.com/fpga](http://www.intel.com/fpga).

C, 27, 3/7 Indicates feature set options, GPIO count, and LVDS transmitter or receiver count. Feature set options:  
C = Compact (single image), F = Flash (dual image with RSU), A = Analog (analog features block).  
Each has added premiums.

— Indicates pin migration.

# Intel eASIC Devices Overview

[intel.com/easic](https://intel.com/easic)

Intel eASIC devices are structured ASICs, an intermediary technology between FPGAs and standard-cell ASICs, that provide lower unit cost and lower power compared to FPGAs. These devices provide faster time to market and lower non-recurring engineering cost compared to standard-cell ASICs. The new Intel eASIC N5X devices, previously codenamed Diamond Mesa, include a hard processor system and secure device managers that are compatible with Intel FPGAs to extend Intel's logic portfolio offerings.

## Intel eASIC N5X Devices

- 16 nm process
- Up to 80M equivalent ASIC gates
- 250 Mb of true dual port memory
- 32.44 Gbps high-speed transceivers
- Quad-core Arm Cortex-A53 hard processor system

## Intel eASIC N3XS Devices

- 28 nm process
- Up to 52 million equivalent ASIC gates
- 124 Mb of true dual port memory
- 28 Gbps high-speed transceivers

## Intel eASIC N3X Devices

- 28 nm
- Up to 5 million equivalent logic gates
- Up to 15.049 Kb of true dual port memory
- Up to 18 12.5 Gbps high-speed transceivers

# Intel eASIC N5X Device Features

Product Line	N5X007	N5X015	N5X024	N5X047	N5X088
eCells (M) <sup>1</sup>	0.70	1.47	2.38	4.65	8.83
Equivalent ASIC gates (M)	7	1.5	2.4	4.7	8.8
M10K Memory	1752	3,684	6,004	11,780	22,372
M10K Memory (Mb)	17.94	37.72	61.48	120.63	229.09
128b register file	12,488	26,180	42,560	82,992	157,640
128b register file (Mb)	1.6	3.35	5.45	10.62	20.18
Secure device manager	Secure data manager AES-256/SHA-256 bitstream encryption/authentication, ECDSA 256/384 boot code authentication, side-channel attack protection; three independent user root keys— vendor authenticated boot (VAB), secured data object storage (SDOS), time-and-priority-based key revocation				
Hard Processor System	Quad-core 64 bit Arm Cortex-A53 up to 1.5 GHz with 32 KB I/D cache, NEON coprocessor, 1 MB L2 cache, direct memory access (DMA), system memory management unit, cache coherency unit, hard memory controllers for DDR4/LPDDR4/LPDDR4x, USB 2.0x2, 1G EMAC x3, UART x2, serial peripheral interface (SPI) x4, I2C x5, general purpose timers x7, watchdog timer x4				
SoC I/O EMIF / Pin Mux / Dedicated	140 / 48 / 24	140 / 48 / 24	140 / 48 / 24	140 / 48 / 24	140 / 48 / 24
Maximum GPIO	416	560	682	682	1114
Transceiver 32	16	24	32	64	80

## Package Examples – Packages Can be Customized Per Application Requirements

FC676, FC1085 (27x27 mm)	Yes	–	–	–	–
FC780, FC1221 (29x29 mm)	Yes	Yes	–	–	–
FC896, FC1440 (31x31 mm)	Yes	Yes	Yes	–	–
FC1152 (35x35 mm)	Yes	Yes	Yes	–	–
FC1517 (40x40 mm)	–	Yes	Yes	Yes	Yes
FC1760 (42.5x42.5 mm)	–	–	Yes	Yes	Yes
FC1932 (45x45 mm)	–	–	–	–	Yes
FC2205 (47.5x47.5 mm)	–	–	–	–	Yes
FC2397 (50x50 mm)	–	–	–	–	Yes

### Notes:

1. eCell can be configured as logic, adders, and/or registers and are roughly equivalent to a 4-input logic element capacity.

# Intel eASIC N3XS Device Features

Product Line	N3XSTe3	N3XSTe5	N3XSTe9	N3XSTe11	N3XSTe15
Equivalent eCells (K)	410	1,040	1,558	3,863	5,262
Equivalent ASIC gates (M)	4	10	16	39	52
LCells	556,800	1,412,880	2,115,840	5,247,840	7,147,920
ACells	172,800	438,480	656,640	1,628,640	2,218,320
eDFFs	230,400	584,640	875,520	2,171,520	2,957,760
bRAM18K blocks (18 Kbit size)	456	1,176	1,776	4,446	6,084
bRAM18K (Kbits)	8,405	21,676	32,735	81,949	112,140
Regfile2K blocks (2 Kbit size)	450	1,161	1,751	4,431	5,977
Regfile2K (Kbits)	922	2,378	3,607	9,075	12,241
Total Memory (Kbits)	9,327	24,054	36,342	91,023	124,381
PLLs	6	12	14	20	24
MGIO 16 (16.3 Gbps)	8	12	32	24	32
MGIO 28 (28 Gbps)	0	0	0	24	32
Legacy I/O	62	62	62	62	62
High-Speed I/O	232	372	522	738	882

## Package Examples – Packages Can be Customized Per Application Requirements

CS484	Yes	–	–	–	–
FC484	Yes	Yes	–	–	–
FC529	–	Yes	Yes	–	–
FC572	Yes	Yes	Yes	–	–
FC676	Yes	Yes	Yes	Yes	–
FC780	–	Yes	Yes	Yes	Yes
FC1152	–	–	Yes	Yes	Yes
FC1517	–	–	–	–	Yes

# Intel eASIC N3X Device Features

Product Line	N3XT 500
eCells	503,424
eDFFs	346,104
Full Adders	503,424
bRAM Kbits	15,409
bRAM blocks	1,672
PLL	16
DLL	42
MGIO-T	18 (12.5 Gbps)

## Package Examples – Packages Can be Customized Per Application Requirements

CS160 (7x11 mm)	4/30
FC484 (23 mm)	8/316
FC672 (27 mm)	8/316
FC780 (29 mm)	14/336
FC896 (31 mm)	18/336
FC1152 (35 mm)	18/392

# Arria V FPGA and SoC Features

Product Line		Arria V GX FPGAs <sup>1</sup>								
		5AGXA1	5AGXA3	5AGXA5	5AGXA7	5AGXB1	5AGXB3	5AGXB5	5AGXB7	5AGTC3
Resources	LEs (K)	75	156	190	242	300	362	420	504	156
	ALMs	28,302	58,900	71,698	91,680	113,208	136,880	158,491	190,240	58,900
	Registers	113,208	235,600	286,792	366,720	452,832	547,520	633,964	760,960	235,600
	M10K memory blocks	800	1,051	1,180	1,366	1,510	1,726	2,054	2,414	1,051
	M20K memory blocks	–	–	–	–	–	–	–	–	–
	M10K memory (Kb)	8,000	10,510	11,800	13,660	15,100	17,260	20,540	24,140	10,510
	M20K memory (Kb)	–	–	–	–	–	–	–	–	–
	MLAB memory (Kb)	463	961	1,173	1,448	1,852	2,098	2,532	2,906	961
	Variable-precision DSP blocks	240	396	600	800	920	1,045	1,092	1,156	396
	18 x 18 multipliers	480	792	1,200	1,600	1,840	2,090	2,184	2,312	792
Clocks, Maximum I/O Pins, and Architectural Features	Processor cores (Arm Cortex-A9)	–	–	–	–	–	–	–	–	–
	Maximum CPU clock frequency (GHz)	–	–	–	–	–	–	–	–	–
	Global clock networks	16	16	16	16	16	16	16	16	16
	PLLs <sup>3</sup> (FPGA)	10	10	12	12	12	12	16	16	10
	PLLs (HPS)	–	–	–	–	–	–	–	–	–
	I/O voltage levels supported (V)									
	I/O standards supported	LVTTTL, LVCMOS, PCI, PCI-X, LVDS, mini-LVDS, RSDS, LVPECL, SSTL-18 (1 and II), SSTL-15 Differential SSTL-2 (1 and II), Differential								
	Maximum LVDS pairs (receiver/transmitter)	80/67	80/67	136/120	136/120	176/160	176/160	176/160	176/160	80/70
	Transceiver count (6.5536 Gbps)	9	9	24	24	24	24	36	36	3
	Transceiver count (10.3125 Gbps) <sup>5</sup>	–	–	–	–	–	–	–	–	4
	Transceiver count (12.5 Gbps)	–	–	–	–	–	–	–	–	–
	PCI Express hardened IP blocks (2.0 x4)	1	1	2	2	2	2	2	2	1
	PCI Express hardened IP blocks (2.0 x8, 3.0)	–	–	–	–	–	–	–	–	–
	GPIOs (FPGA)	–	–	–	–	–	–	–	–	–
	GPIOs (HPS)	–	–	–	–	–	–	–	–	–
Hard memory controllers <sup>6</sup> (FPGA)	2	2	4	4	4	4	4	4	2	
Hard memory controllers (HPS)	–	–	–	–	–	–	–	–	–	
Memory devices supported										

## Package Options and I/O Pins: GPIO Count, and Transceiver Count

F672 pin (27 mm, 1.0 mm pitch)	336 9,0	336 9,0	336 9,0	336 9,0	–	–	–	–	336 3,4
H780 pin (29 mm, 1.0 mm pitch)	–	–	–	–	–	–	–	–	–
F896 pin (31 mm, 1.0 mm pitch)	416 9,0	416 9,0	384 18,0	384 18,0	384 18,0	384 18,0	–	–	416 3,4
F896 pin (31 mm, 1.0 mm pitch)	320 9,0	320 9,0	320 9,0	320 9,0	320 9,0	–	–	–	320 3,4
F1152 pin (35 mm, 1.0 mm pitch)	–	–	544 24,0	544 24,0	544 24,0	544 24,0	544 24,0	544 24,0	–
F1517 pin (40 mm, 1.0 mm pitch)	–	–	–	–	704 24,0	704 24,0	704 36,0	704 36,0	–

Notes:

- All data is correct at the time of printing, and may be subject to change without prior notice. For the latest information, please visit [www.intel.com/fpga](http://www.intel.com/fpga).
- 1.15 V operation.
- The PLL count includes general-purpose fractional PLLs and transceiver fractional PLLs.
- For Arria V GZ devices, the I/O voltage of 3.3 V compliant, requires a 3.0 V power supply.
- One pair of 10 Gbps transceiver channels can be configured as three 6 Gbps transceiver channels.
- With 16 and 32 bit ECC support.
- These memory interfaces are not available as Intel FPGA IP.
- This memory interface is only available for Arria V GZ devices.

View device ordering codes on [page 59](#).

Arria V GT FPGAs <sup>1</sup>			Arria V GZ FPGAs <sup>1</sup>				Arria V SX SoCs <sup>1</sup>		Arria V ST SoCs <sup>1</sup>	
5AGTC7	5AGTD3	5AGTD7	5AGZE1	5AGZE3	5AGZE5	5AGZE7	5ASXB3	5ASXB5	5ASTD3	5ASTD5
242	362	504	220	360	400	450	350	462	350	462
91,680	136,880	190,240	83,020	135,840	150,960	169,800	132,075	174,340	132,075	174,340
366,720	547,520	760,960	332,080	543,360	603,840	679,200	528,300	697,360	528,300	697,360
1,366	1,726	2,414	-	-	-	-	1,729	2,282	1,729	2,282
-	-	-	585	957	1,440	1,700	-	-	-	-
13,660	17,260	24,140	-	-	-	-	17,290	22,820	17,290	22,820
-	-	-	11,700	19,140	28,800	34,000	-	-	-	-
1,448	2,098	2,906	2,594	4,245	4,718	5,306	2,014	2,658	2,014	2,658
800	1,045	1,156	800	1,044	1,092	1,139	809	1,090	809	1,090
1,600	2,090	2,312	1,600	2,088	2,184	2,278	1,618	2,180	1,618	2,180
-	-	-	-	-	-	-	Dual	Dual	Dual	Dual
-	-	-	-	-	-	-	1.05 <sup>2</sup>	1.05 <sup>2</sup>	1.05 <sup>2</sup>	1.05 <sup>2</sup>
16	16	16	16	16	16	16	16	16	16	16
12	12	16	20	20	24	24	14	14	14	14
-	-	-	-	-	-	-	3	3	3	3

1.2, 1.5, 1.8, 2.5, 3.0, 3.3<sup>4</sup>

(I and II), SSTL-2 (I and II), HSTL-18 (I and II), HSTL-15 (I and II), HSTL-12 (I and II), Differential SSTL-18 (I and II), Differential SSTL-15 (I and II), HSTL-18 (I and II), Differential HSTL-15 (I and II), Differential HSTL-12 (I and II), Differential HSUL-12

136/120	176/160	176/160	108/99	108/99	168/166	168/166	136/120	136/120	136/120	136/120
6	6	6	-	-	-	-	30	30	30	30
12	12	20	-	-	-	-	-	-	16	16
-	-	-	24	24	36	36	-	-	-	-
2	2	2	-	-	-	-	2	2	2	2
-	-	-	1	1	1	1	-	-	-	-
-	-	-	-	-	-	-	540	540	540	540
-	-	-	-	-	-	-	208	208	208	208
4	4	4	-	-	-	-	3	3	3	3
-	-	-	-	-	-	-	1	1	1	1

DDR3, DDR2, DDR II<sup>+</sup>, QDR II, QDR II<sup>+</sup>, RLD RAM II, RLD RAM 3<sup>8</sup>, LPDDR<sup>7</sup>, LPDDR2<sup>7</sup>

-	-	-	-	-	-	-	-	-	-	-
-	-	-	342 12	342 12	-	-	-	-	-	-
384 6,8	384 6,8	-	-	-	-	-	250, 208 12+0	250, 208 12+0	250, 208 12+6	250, 208 12+6
320 3,4	320 3,4	-	-	-	-	-	-	-	-	-
544 6,12	544 6,12	544 6,12	414 24	414 24	534 24	534 24	385, 208 18+0	385, 208 18+0	385, 208 18+8	385, 208 18+8
-	704 6,12	704 6,20	-	-	674 36	674 36	540, 208 30+0	540, 208 30+0	540, 208 30+16	540, 208 30+16

**336  
9,0** For Arria V GX and GT devices, values on top indicate available user I/O pins and values at the bottom indicate the 6.5536 Gbps and 10.3125 Gbps transceiver count. One pair of 10 Gbps transceiver channels can be configured as three 6 Gbps transceiver channels. For Arria V GZ devices, values on top indicate available user I/O pins and values at the bottom indicate the 12.5 Gbps transceiver count.

**250, 208  
12+0** Values on top indicate available FPGA user I/O pins and HPS I/O pins; values at the bottom indicate the 6.5536 Gbps plus 10.3125 Gbps transceiver count.

 Pin migration (same V<sub>cc</sub>, GND, ISP, and input pins). User I/O pins may be less than labeled for pin migration.

 Pin migration is only possible if you use up to 320 I/O pins, up to nine 6.5536 Gbps transceiver count (for Arria V GX devices), and up to four 10.3125 Gbps transceiver count (for Arria V GT devices).



# Cyclone V FPGA Features

Product Line		Cyclone V E FPGAs <sup>1</sup>				
		5CEA2	5CEA4	5CEA5	5CEA7	5CEA9
Resources	LEs (K)	25	49	77	149.5	301
	ALMs	9,434	18,480	29,080	56,480	113,560
	Registers	37,736	73,920	116,320	225,920	454,240
	M10K memory blocks	176	308	446	686	1,220
	M10K memory (Kb)	1,760	3,080	4,460	6,860	12,200
	MLAB memory (Kb)	196	303	424	836	1,717
	Variable-precision DSP blocks	25	66	150	156	342
	18 x 18 multipliers	50	132	300	312	684
Clocks, Maximum I/O Pins, and Architectural Features	Global clock networks	16	16	16	16	16
	PLLs <sup>2</sup> (FPGA)	4	4	6	7	8
	I/O voltage levels supported (V)					
	I/O standards supported	LVTTTL, LVCMOS, PCI, PCI-X, LVDS, mini-LVDS, RSDS, Differential SSTL-18 (I and II), Differential SSTL-15 (I and II), Differential SSTL-2				
	Maximum LVDS pairs (receiver/transmitter)	56/56	56/56	60/60	120/120	120/120
	Transceiver count (3.125 Gbps)	–	–	–	–	–
	Transceiver count (6.144 Gbps) <sup>3</sup>	–	–	–	–	–
	PCI Express hardened IP blocks (1.0) <sup>5</sup>	–	–	–	–	–
	PCI Express hardened IP blocks (2.0)	–	–	–	–	–
	Hard memory controllers <sup>6</sup> (FPGA)	1	1	2	2	2
	Memory devices supported					

## Package Options and I/O Pins: GPIO Count, and Transceiver Count

M301 pin (11 mm, 0.5 mm pitch)					
M383 pin (13 mm, 0.5 mm pitch)	223	223	175		
M484 pin (15 mm, 0.5 mm pitch)				240	
U324 pin (15 mm, 0.8 mm pitch)	176	176			
U484 pin (19 mm, 0.8 mm pitch)	224	224	224	240	240
F256 pin (17 mm, 1.0 mm pitch)	128	128			
F484 pin (23 mm, 1.0 mm pitch)	224	224	240	240	224
F672 pin (27 mm, 1.0 mm pitch)				336	336
F896 pin (31 mm, 1.0 mm pitch)				480	480
F1152 pin (35 mm, 1.0 mm pitch)					

Notes:

1. All data is correct at the time of printing, and may be subject to change without prior notice. For the latest information, please visit [www.intel.com/fpga](http://www.intel.com/fpga).
2. The PLL count includes general-purpose fractional PLLs and transceiver fractional PLLs.
3. Automotive grade Cyclone V GT FPGAs include a 5 Gbps transceiver.
4. Transceiver counts shown are for ≤ 5 Gbps. The 6 Gbps channel count support depends on package and channel usage. Refer to [Cyclone V Device Handbook Volume 2: Transceivers for guidelines](#).
5. Only one PCIe hard IP block supported in M301, M484, and U324 packages.
6. Includes 16 and 32 bit error correction code ECC support.

View device ordering codes on [page 60](#).

Cyclone V GX FPGAs <sup>1</sup>					Cyclone V GT FPGAs <sup>1</sup>		
5CGXC3	5CGXC4	5CGXC5	5CGXC7	5CGXC9	5CGTD5	5CGTD7	5CGTD9
35.5	50	77	149.5	301	77	149.5	301
13,460	18,868	29,080	56,480	113,560	29,080	56,480	113,560
53,840	75,472	116,320	225,920	454,240	116,320	225,920	454,240
135	250	446	686	1,220	446	686	1,220
1,350	2,500	4,460	6,860	12,200	4,460	6,860	12,200
291	295	424	836	1,717	424	836	1,717
57	70	150	156	342	150	156	342
114	140	300	312	684	300	312	684
16	16	16	16	16	16	16	16
4	6	6	7	8	6	7	8

1.1, 1.2, 1.5, 1.8, 2.5,3.3

LVPECL, SSTL-18 (I and II), SSTL-15 (I and II), SSTL-2 (I and II), HSTL-18 (I and II), HSTL-15 (I and II), HSTL-12 (I and II), (I and II), Differential HSTL-18 (I and II), Differential HSTL-15 (I and II), Differential HSTL-12 (I and II), Differential HSUL-12, HiSpi, SLVS, Sub-LVDS

52/52	84/84	84/84	120/120	140/140	84/84	120/120	140/140
3	6	6	9	12	–	–	–
–	–	–	–	–	6 <sup>4</sup>	9 <sup>4</sup>	12 <sup>4</sup>
1	2	2	2	2	–	–	–
–	–	–	–	–	2	2	2
1	2	2	2	2	2	2	2

DDR3, DDR2, LPDDR2

	129 4	129 4			129 4		
	175 6	175 6			175 6		
			240 3			240 3	
144 3							
208 3	224 6	224 6	240 6	240 5	224 6	240 6	240 5
208 3	240 6	240 6	240 6	224 6	240 6	240 6	224 6
	336 6	336 6	336 9	336 9	336 6	336 9	336 9
			480 9	480 12		480 9	480 12
				560 12			560 12

129  
4 Values on top indicate available user I/O pins; values at the bottom indicate the 3.125 Gbps, 5 Gbps, or 6.144 Gbps transceiver count.

Pin migration (same V<sub>cc</sub>, GND, ISP, and input pins). User I/O pins may be less than labeled for pin migration.

For FPGAs: Pin migration is only possible if you use only up to 175 GPIOs.

# Cyclone V SoC Features

Product Line		Cyclone V SE SoCs <sup>1</sup>			
		5CSEA2	5CSEA4	5CSEA5	5CSEA6
Resources	LEs (K)	25	40	85	110
	ALMs	9,434	15,094	32,075	41,509
	Registers	37,736	60,376	128,300	166,036
	M10K memory blocks	140	270	397	557
	M10K memory (Kb)	1,400	2,700	3,970	5,570
	MLAB memory (Kb)	138	231	480	621
	Variable-precision DSP blocks	36	84	87	112
	18 x 18 multipliers	72	168	174	224
Clocks, Maximum I/O Pins, and Architectural Features	Processor cores (Arm Cortex-A9)	Single or dual	Single or dual	Single or dual	Single or dual
	Maximum CPU clock frequency (MHz)	925	925	925	925
	Global clock networks	16	16	16	16
	PLLs <sup>2</sup> (FPGA)	5	5	6	6
	PLLs (HPS)	3	3	3	3
	I/O voltage levels supported (V)				
	I/O standards supported	LVTTTL, LVCMOS, PCI, PCI-X, LVDS, mini-LVDS, RSDS, Differential SSTL-18 (I and II), Differential SSTL-15 (I and II), Differential SSTL-2			
	Maximum LVDS pairs (receiver/transmitter)	37/32	37/32	72/72	72/72
	Transceiver count (3.125 Gbps)	–	–	–	–
	Transceiver count (6.144 Gbps)	–	–	–	–
	PCI Express hardened IP blocks (1.0)	–	–	–	–
	PCI Express hardened IP blocks (2.0)	–	–	–	–
	GPIOs (FPGA)	145	145	288	288
	GPIOs (HPS)	181	181	181	181
	Hard memory controllers <sup>5</sup> (FPGA)	1	1	1	1
Hard memory controllers <sup>5</sup> (HPS)	1	1	1	1	
Memory devices supported					

## Package Options and I/O Pins: General-Purpose I/O (GPIO) Count, and Transceiver Count

U484 pin (19 mm, 0.8 mm pitch)	66, 151 0	66, 151 0	66, 151 0	66, 151 0
U672 pin (23 mm, 0.8 mm pitch)	145, 181 0	145, 181 0	145, 181 0	145, 181 0
F896 pin (31 mm, 1.0 mm pitch)			288, 181 0	288, 181 0

Notes:

- All data is correct at the time of printing, and may be subject to change without prior notice. For the latest information, please visit [www.intel.com/fpga](http://www.intel.com/fpga).
- The PLL count includes general-purpose fractional PLLs and transceiver fractional PLLs.
- Transceiver counts shown are for ≤ 5 Gbps. The 6 Gbps channel count support depends on package and channel usage. Refer to [Cyclone V Device Handbook Volume 2: Transceivers for guidelines](#).
- One PCI Express hard IP block in U672 package.
- With 16 and 32 bit ECC support.

View device ordering codes on [page 60](#).

Cyclone V SX SoCs <sup>1</sup>				Cyclone V ST SoCs <sup>1</sup>	
5CSXC2	5CSXC4	5CSXC5	5CSXC6	5CSTD5	5CSTD6
25	40	85	110	85	110
9,434	15,094	32,075	41,509	32,075	41,509
37,736	60,376	128,300	166,036	128,300	166,036
140	270	397	557	397	557
1,400	2,700	3,970	5,570	3,970	5,570
138	231	480	621	480	621
36	84	87	112	87	112
72	168	174	224	174	224
Dual	Dual	Dual	Dual	Dual	Dual
925	925	925	925	925	925
16	16	16	16	16	16
5	5	6	6	6	6
3	3	3	3	3	3

1.1, 1.2, 1.5, 1.8, 2.5,3.3

LVPECL, SSTL-18 (I and II), SSTL-15 (I and II), SSTL-2 (I and II), HSTL-18 (I and II), HSTL-15 (I and II), HSTL-12 (I and II), (I and II), Differential HSTL-18 (I and II), Differential HSTL-15 (I and II), Differential HSTL-12 (I and II), Differential HSUL-12, HiSpi, SLVS, Sub-LVDS

37/32	37/32	72/72	72/72	72/72	72/72
6	6	9	9	–	–
–	–	–	–	9 <sup>3</sup>	9 <sup>3</sup>
2	2	2 <sup>4</sup>	2 <sup>4</sup>	–	–
–	–	–	–	2	2
145	145	288	288	288	288
181	181	181	181	181	181
1	1	1	1	1	1
1	1	1	1	1	1

DDR3, DDR2, LPDDR2

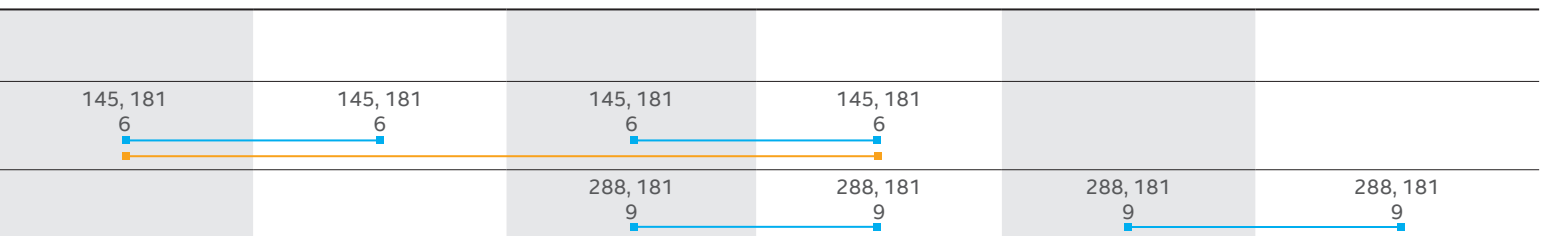

66, 151  
0 Values on top indicate available FPGA user I/O pins and HPS I/O pins; values at the bottom indicate the 3.125 Gbps or 5 Gbps transceiver count.

Pin migration (same V<sub>cc</sub>, GND, ISP, and input pins). User I/O pins may be less than labeled for pin migration.

For SoCs: Pin migration is only possible if you use only up to 138 GPIOs.

# Cyclone IV FPGA Features

Product Line		Cyclone IV GX FPGAs <sup>1</sup>					
		EP4CGX15	EP4CGX22	EP4CGX30	EP4CGX50	EP4CGX75	EP4CGX110
Resources	LEs (K)	14	21	29	50	74	109
	M9K memory blocks	60	84	120	278	462	666
	Embedded memory (Kb)	540	756	1,080	2,502	4,158	5,490
	18 x 18 multipliers	0	40	80	140	198	280
Clocks, Maximum I/O Pins, and Architectural Features	Global clock networks	20	20	20	30	30	30
	PLLs	3	4	4	8	8	8
	I/O voltage levels supported (V)						
	I/O standards supported	LVTTTL, LVCMOS, PCI, PCI-X, LVDS, mini-LVDS, RSDS, LVPECL, SSTL-18 Differential SSTL-15 (I and II), Differential SSTL-2					
	Emulated LVDS channels	9	40	40	73	73	139
	Maximum LVDS pairs, 840 Mbps (receive/transmit)	7/7	14/14	14/14	49/49	49/49	59/59
	Transceiver count <sup>2</sup> (2.5 Gbps/3.124 Gbps)	2/0	2, 0 / 4, 0	4, 0 / 0, 4 <sup>3</sup>	0, 8	0, 8	0, 8
	PCI Express hardened IP blocks (Base specification, Rev 1.1, 2.0, and so on)	1	1	1	1	1	1
	Memory devices supported						

## Package Options and I/O Pins: General-Purpose I/O (GPIO) Count and Transceiver Count

E144 pin <sup>4</sup> (22 mm, 0.5 mm pitch)	-	-	-	-	-	-
M164 pin (8 mm, 0.5 mm pitch)	-	-	-	-	-	-
M256 pin (9 mm, 0.5 mm pitch)	-	-	-	-	-	-
U256 pin (14 mm, 0.8 mm pitch)	-	-	-	-	-	-
U484 pin (19 mm, 0.8 mm pitch)	-	-	-	-	-	-
F169 pin (14 mm, 1.0 mm pitch)	72 2	72 2	72 2	-	-	-
F256 pin (17 mm, 1.0 mm pitch)	-	-	-	-	-	-
F324 pin (19 mm, 1.0 mm pitch)	-	150 4	150 4	-	-	-
F484 pin (23 mm, 1.0 mm pitch)	-	-	290 4	290 4	290 4	270 4
F672 pin (27 mm, 1.0 mm pitch)	-	-	-	310 8	310 8	393 8
F780 pin (29 mm, 1.0 mm pitch)	-	-	-	-	-	-
F896 pin (31 mm, 1.0 mm pitch)	-	-	-	-	-	475 8

Notes:

1. All data is correct at the time of printing, and may be subject to change without prior notice. For the latest information, please visit [www.intel.com/fpga](http://www.intel.com/fpga).
2. Transceiver performance varies by product line and package offering.
3. EP4CGX30 supports 3.125 Gbps transceivers only in F484 package option.
4. Enhanced thin quad flat pack (EQFP).

View device ordering codes on [page 61](#).

	Cyclone IV E FPGAs <sup>1</sup>								
EP4CGX150	EP4CE6	EP4CE10	EP4CE15	EP4CE22	EP4CE30	EP4CE40	EP4CE55	EP4CE75	EP4CE115
150	6	10	15	22	29	40	56	75	114
720	30	46	56	66	66	126	260	305	432
6,480	270	414	504	594	594	1,134	2,340	2,745	3,888
360	15	23	56	66	66	116	154	200	266
30	10	10	20	20	20	20	20	20	20
8	2	2	4	4	4	4	4	4	4

1.2, 1.5, 1.8, 2.5, 3.3

(1 and II), SSTL-15 (I and II), SSTL-2 (I and II), HSTL-18 (I and II), HSTL-15 (I and II), HSTL-12 (I and II), Differential SSTL-18 (I and II), (I and II), Differential HSTL-18 (I and II), Differential HSTL-15 (I and II), Differential HSTL-12 (I and II), Differential HSUL-12

139	66	66	137	52	224	224	160	178	230
59/59	-	-	-	-	-	-	-	-	-
0, 8	-	-	-	-	-	-	-	-	-
1	-	-	-	-	-	-	-	-	-

DDR2, DDR, SDR

-	91	91	81	79	-	-	-	-	-
-	-	-	90	-	-	-	-	-	-
-	-	-	166	-	-	-	-	-	-
-	179	179	165	153	-	-	-	-	-
-	-	-	-	-	328	328	324	292	-
-	-	-	-	-	-	-	-	-	-
-	179	179	165	153	-	-	-	-	-
-	-	-	-	-	193	193	-	-	-
270 4	-	-	343	-	328	328	324	292	280
393 8	-	-	-	-	-	-	-	-	-
-	-	-	-	-	532	532	374	426	528
475 8	-	-	-	-	-	-	-	-	-

$\frac{72}{2}$

Values on top indicate available user I/O pins; values at the bottom indicate the 2.5 Gbps or 3.125 Gbps transceiver count.

Pin migration (same Vcc, GND, ISP, and input pins). User I/Os may be less than labeled for pin migration.

# MAX V CPLD Features

Product Line				
		5M40Z	5M80Z	5M160Z
Resources	LEs	40	80	160
	Equivalent macrocells <sup>2</sup>	32	64	128
	Pin-to-pin delay (ns)	7.5	7.5	7.5
	User flash memory (Kb)	8	8	8
	Logic convertible to memory <sup>3</sup>	Yes	Yes	Yes
Clocks, Maximum I/O Pins, and Architectural Features	Internal oscillator	✓	✓	✓
	Fast power-on reset	✓	✓	✓
	Boundary-scan JTAG	✓	✓	✓
	JTAG ISP	✓	✓	✓
	Fast input registers	✓	✓	✓
	Programmable register power-up	✓	✓	✓
	JTAG translator	✓	✓	✓
	Real-time ISP	✓	✓	✓
	MultiVolt I/Os (V)			1.2, 1.5, 1.8, 2
	I/O power banks	2	2	2
	Maximum output enables	54	54	79
	LVTTL/LVCMOS	✓	✓	✓
	LVDS outputs	✓	✓	✓
	32 bit, 66 MHz PCI compliant	–	–	–
	Schmitt triggers	✓	✓	✓
	Programmable slew rate	✓	✓	✓
	Programmable pull-up resistors	✓	✓	✓
	Programmable GND pins	✓	✓	✓
	Open-drain outputs	✓	✓	✓
	Bus hold	✓	✓	✓

## Package Options and I/O Pins<sup>5</sup>

E64 pin (9 mm, 0.4 mm pitch)	54	54	54
T100 pin <sup>6</sup> (16 mm, 0.5 mm pitch)	–	79	79
T144 pin <sup>6</sup> (22 mm, 0.5 mm pitch)	–	–	–
M64 pin (4.5 mm, 0.5 mm pitch)	30	30	–
M68 pin (5 mm, 0.5 mm pitch)	–	52	52
M100 pin (6 mm, 0.5 mm pitch)	–	–	79
M144 pin (7 mm, 0.5 mm pitch)	–	–	–
M256 pin (11 mm, 0.5 mm pitch)	–	–	–
U256 pin (14 mm, 0.8 mm pitch)	–	–	–
F100 pin (11 mm, 1.0 mm pitch)	–	–	–
F256 pin (17 mm, 1.0 mm pitch)	–	–	–
F324 pin (19 mm, 1.0 mm pitch)	–	–	–

### Notes:

- All data is correct at the time of printing, and may be subject to change without prior notice. For the latest information, please visit [www.intel.com/fpga](http://www.intel.com/fpga).
- Typical equivalent macrocells.
- Unused LEs can be converted to memory. The total number of available LE RAM bits depends on the memory mode, depth, and width configurations of the instantiated memory.

- An external resistor must be used for 5.0 V tolerance.
- For temperature grades of specific packages (commercial, industrial, or extended temperatures), refer to Intel's online selector guide.
- Thin quad flat pack (TQFP).

View device ordering codes on [page 62](#).

MAX V CPLDs <sup>1</sup>				
	5M240Z	5M570Z	5M1270Z	5M2210Z
	240	570	1,270	2,210
	192	440	980	1,700
	7.5	9.0	6.2	7.0
	8	8	8	8
	Yes	Yes	Yes	Yes
	✓	✓	✓	✓
	✓	✓	✓	✓
	✓	✓	✓	✓
	✓	✓	✓	✓
	✓	✓	✓	✓
	✓	✓	✓	✓
	✓	✓	✓	✓
1.5, 3.3			1.2, 1.5, 1.8, 2.5, 3.3, 5.0 <sup>4</sup>	
	2	2	4	4
	114	159	271	271
	✓	✓	✓	✓
	✓	✓	✓	✓
	-	-	✓ <sup>4</sup>	✓ <sup>4</sup>
	✓	✓	✓	✓
	✓	✓	✓	✓
	✓	✓	✓	✓
	✓	✓	✓	✓
	✓	✓	✓	✓
	✓	✓	✓	✓
	-	-	-	-
	79	74	-	-
	114	114	114	-
	-	-	-	-
	52	-	-	-
	79	74	-	-
	-	-	-	-
	-	-	-	-
	-	-	-	-
	-	159	211	204
	-	-	271	271

<sup>54</sup> Number indicates available user I/O pins.

Pin migration (same Vcc, GND, ISP, and input pins). User I/Os may be less than labeled for pin migration.



# Ordering Codes

## Ordering Information for Intel Agilex 7 FPGAs F-Series, I-Series and M-Series

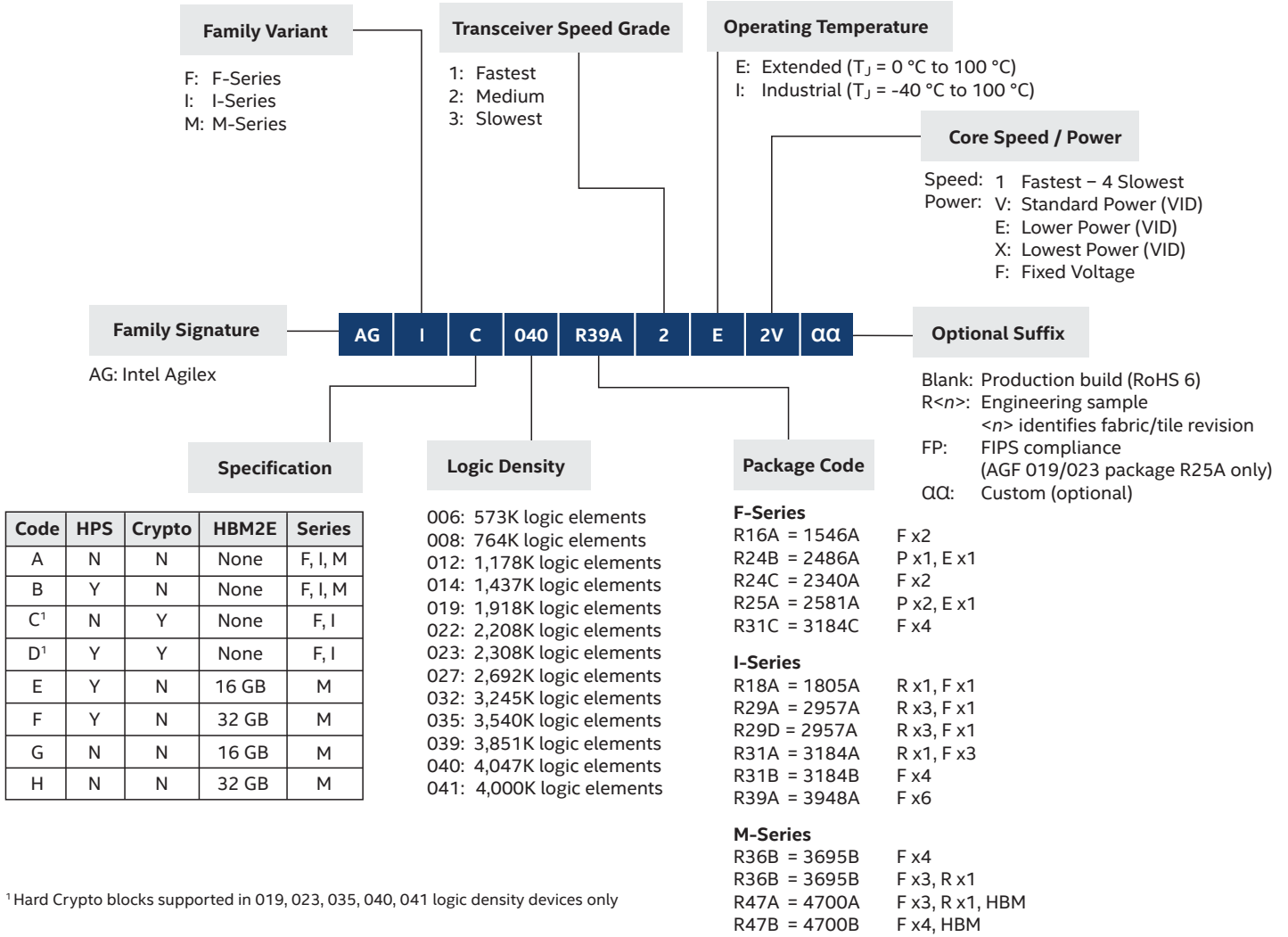

### Ordering Information for Intel Stratix 10 (GX, SX, TX) Devices

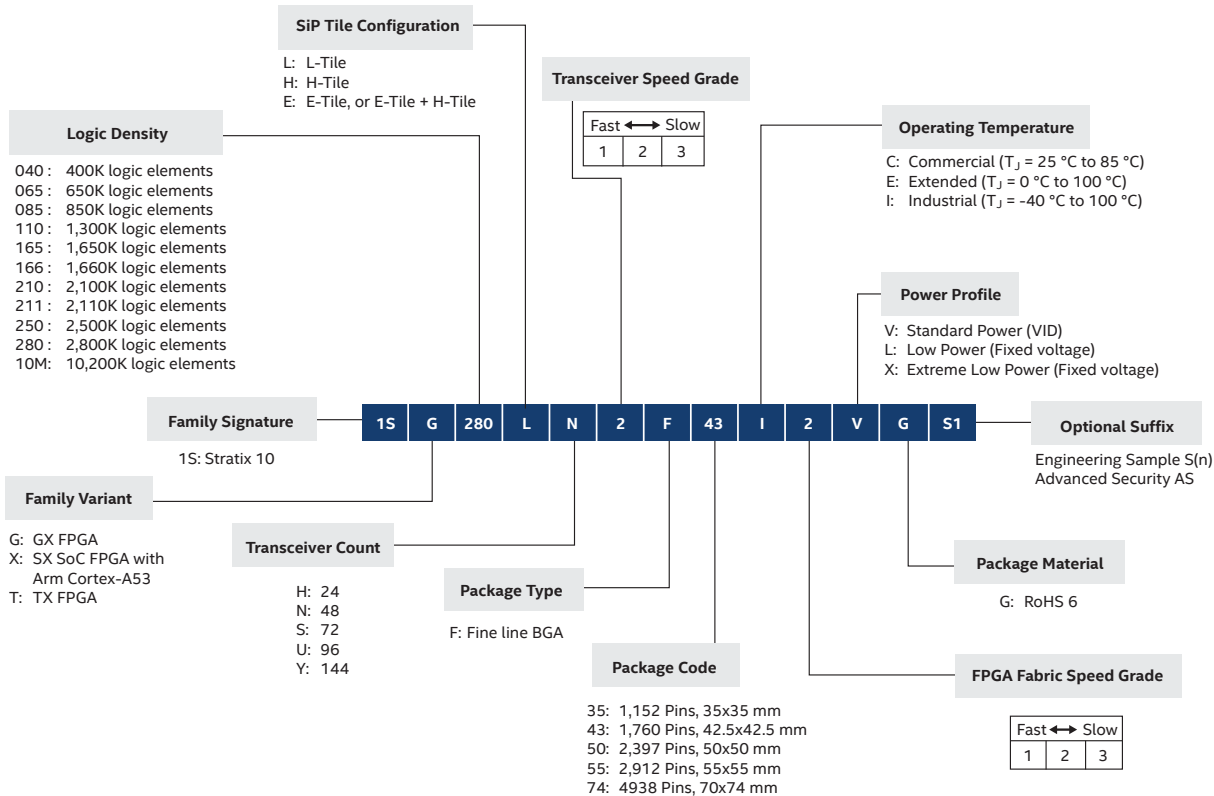

### Ordering Information for Intel Stratix 10 (MX) Devices

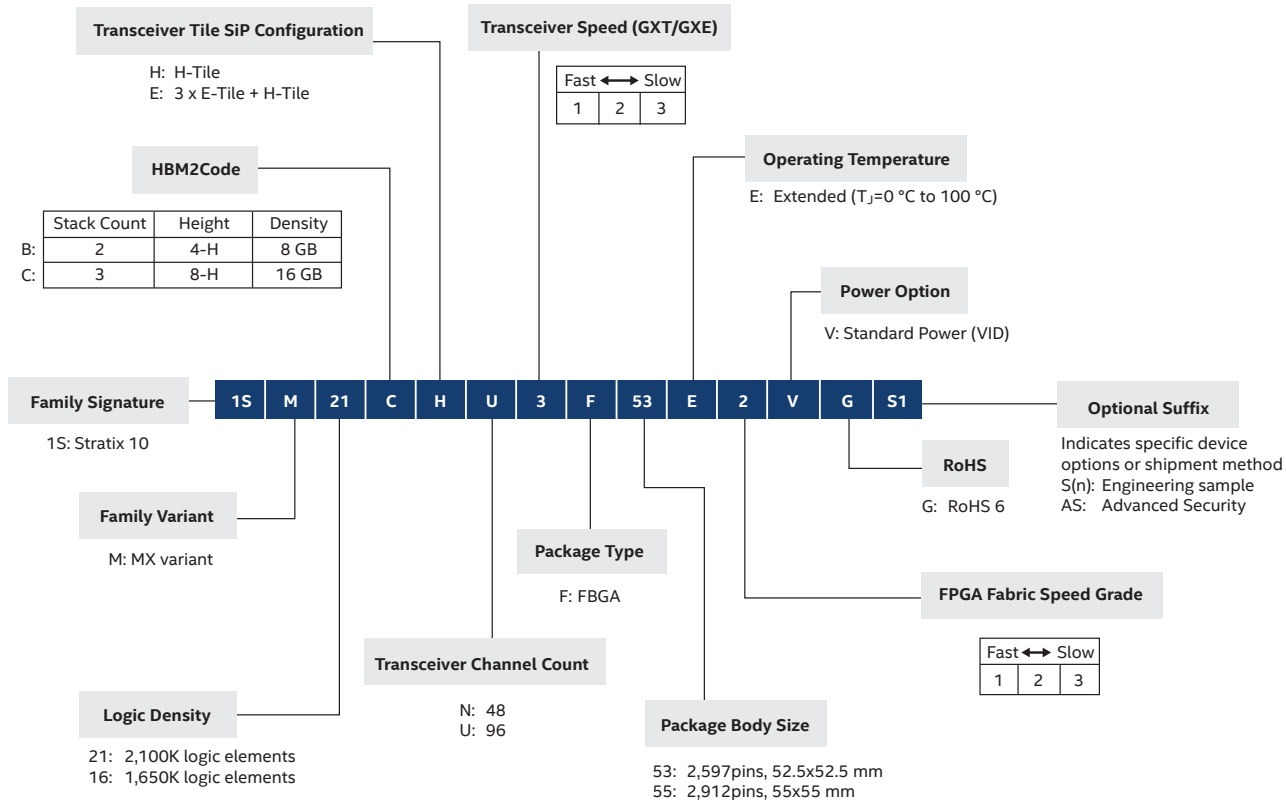

### Ordering Information for Intel Stratix 10 (DX) Devices

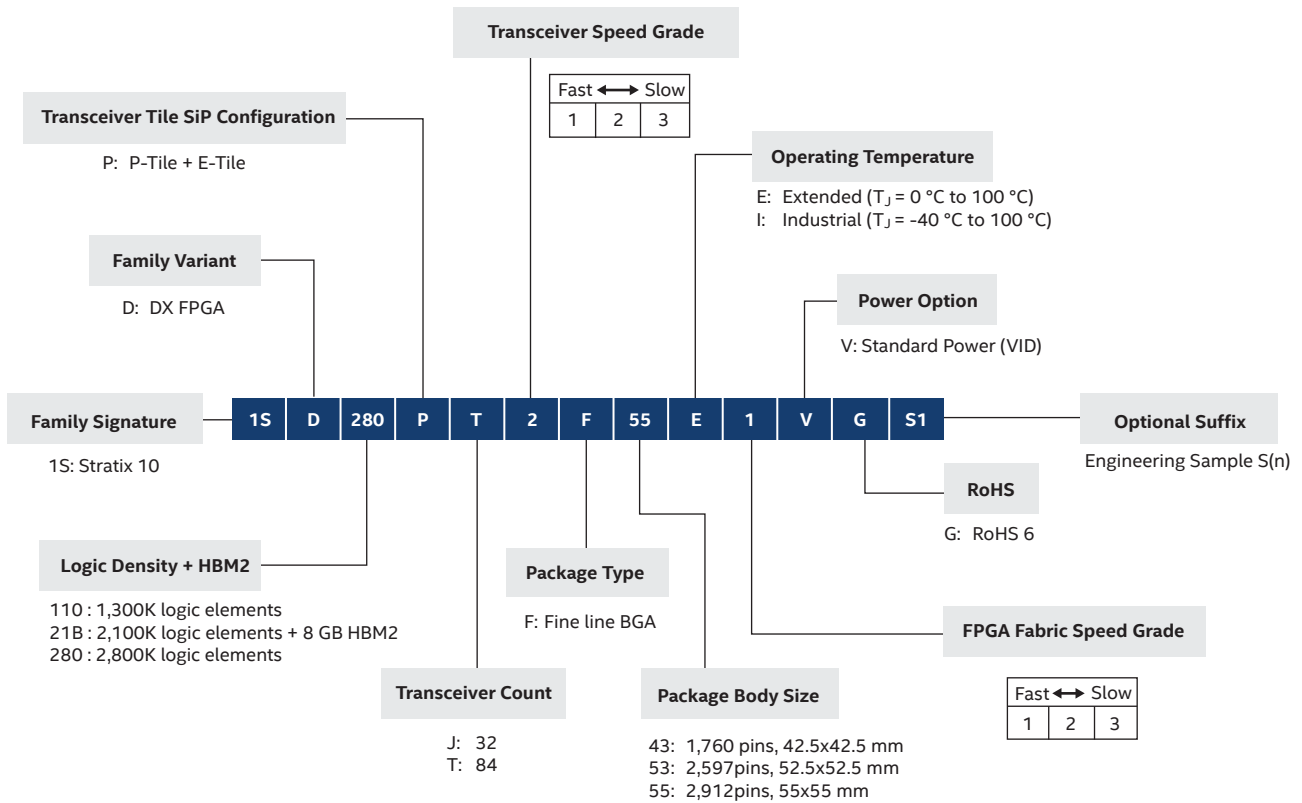

### Ordering Information for Intel Arria 10 (GX, SX, GT) Devices

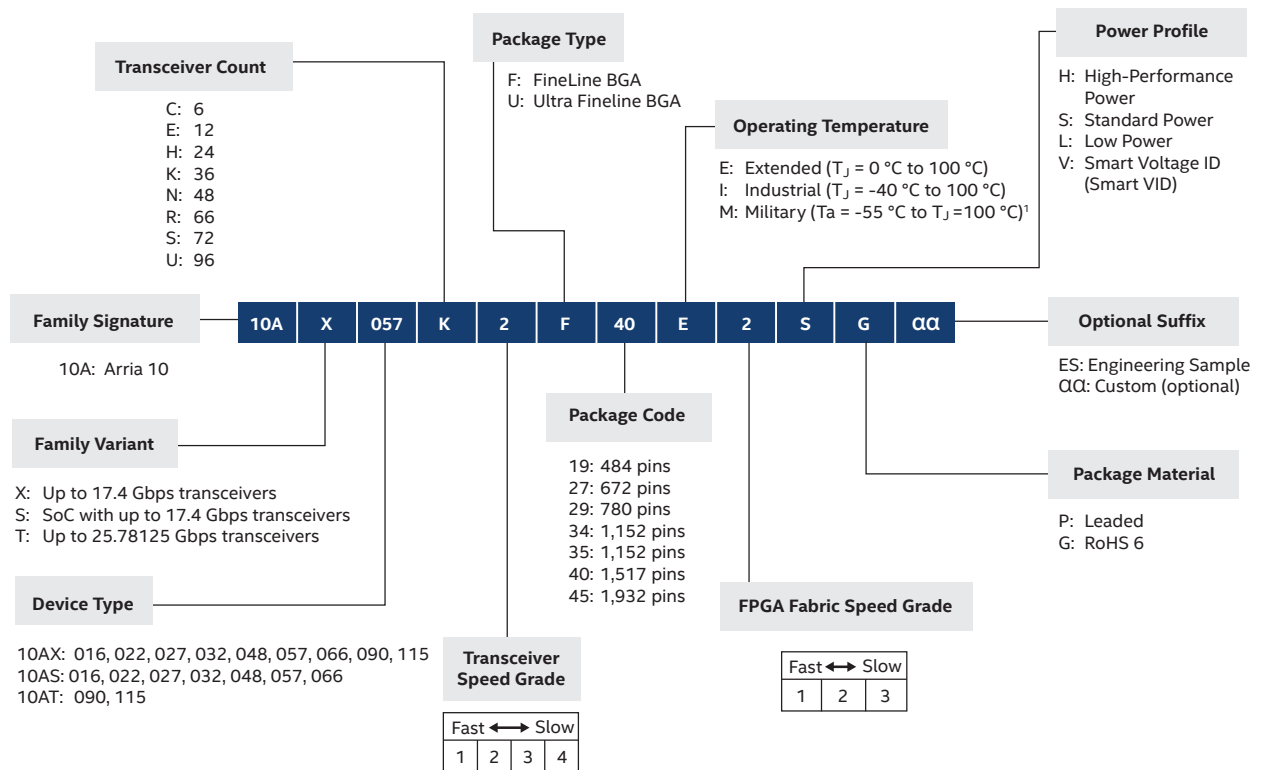

<sup>1</sup> For details, refer to the Intel® Arria® 10 Military Temperature Range Support Technical Brief.

### Ordering Information for Intel Cyclone 10 Devices

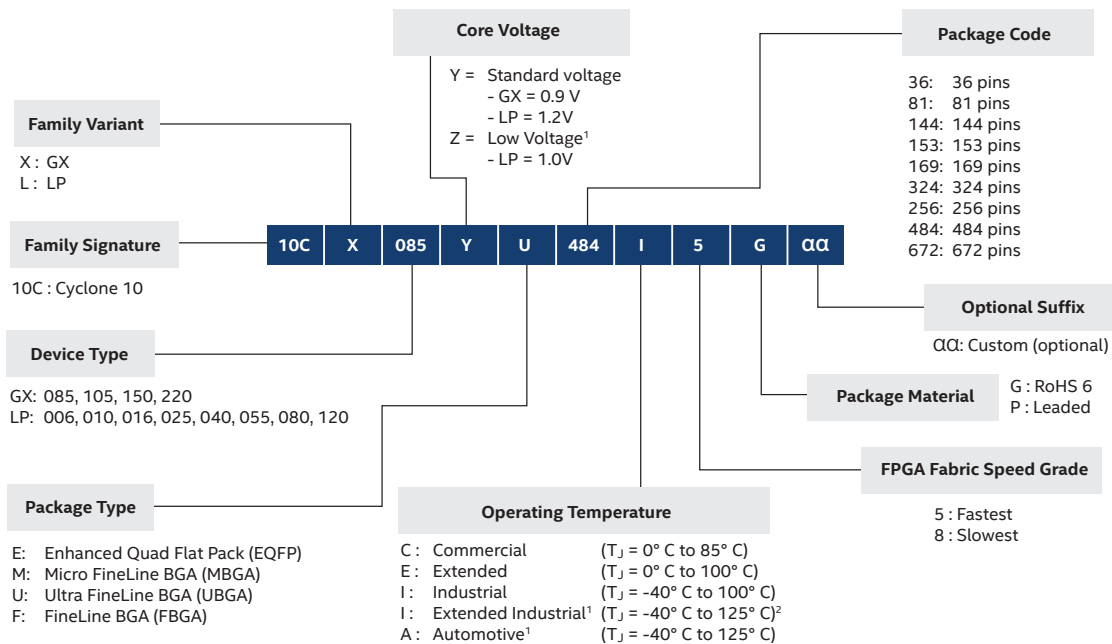

<sup>1</sup> Only available on Intel Cyclone 10 LP.

<sup>2</sup> For details, refer to the [Extended Temperature Device Support web page](#).

### Ordering Information for Intel MAX 10 Devices

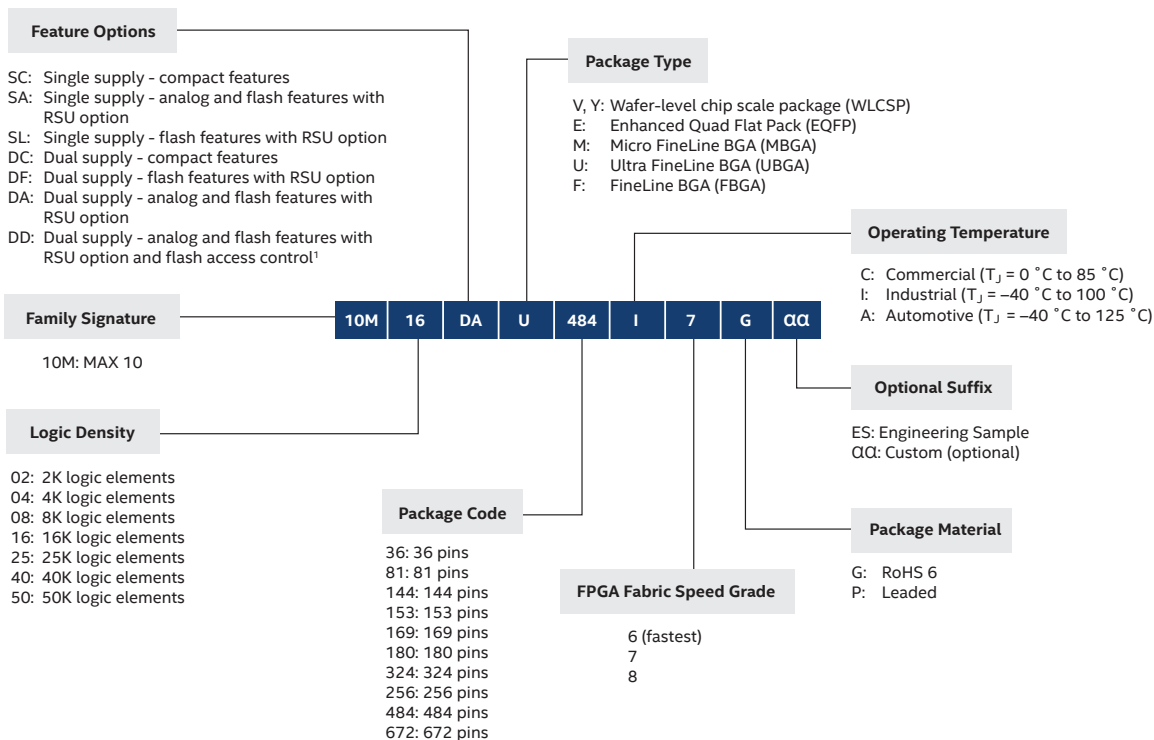

<sup>1</sup> DD OPN available only on 10M40 and 10M50 devices with F256, F484, and F762 packages.

### Ordering Information for Arria V (GT, GX, GZ) Devices

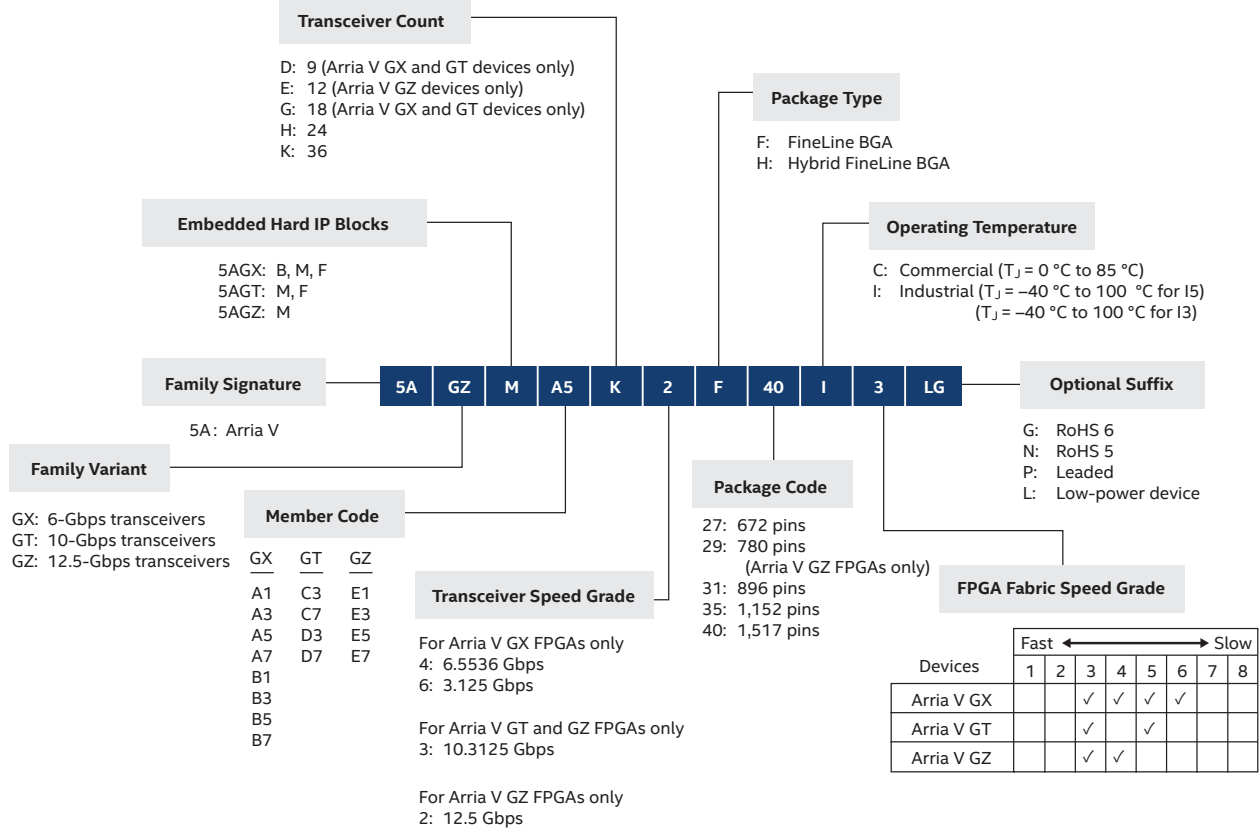

### Ordering Information for Arria V (SX, ST) SoCs

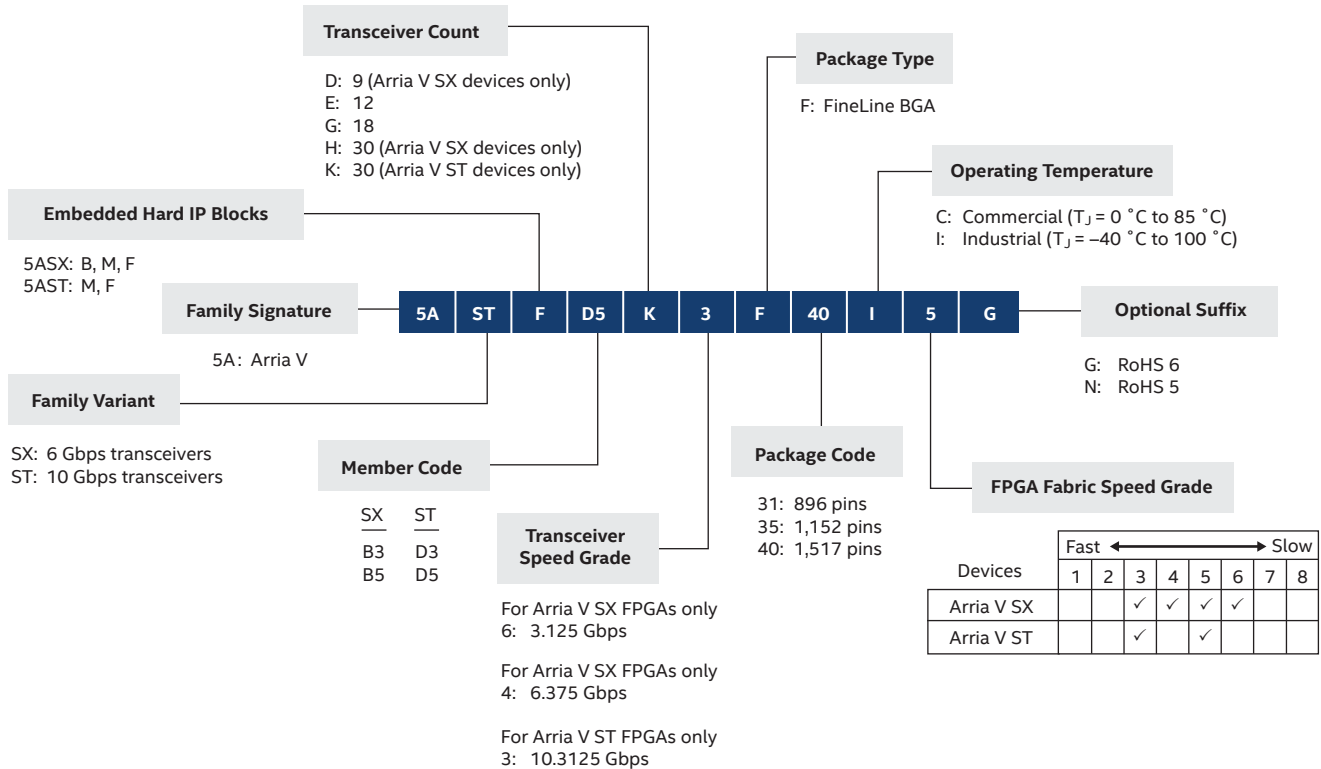

### Ordering Information for Cyclone V (E, GX, GT) Devices

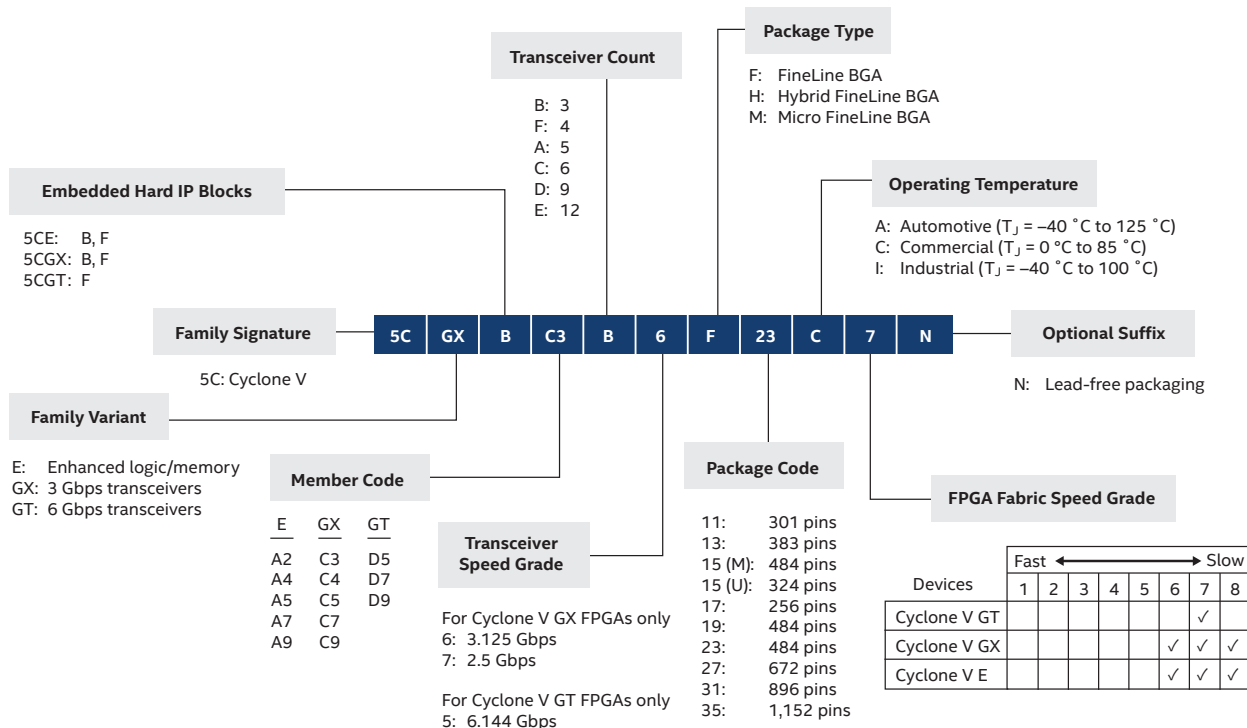

### Ordering Information for Cyclone V (SE, SX, ST) SoCs

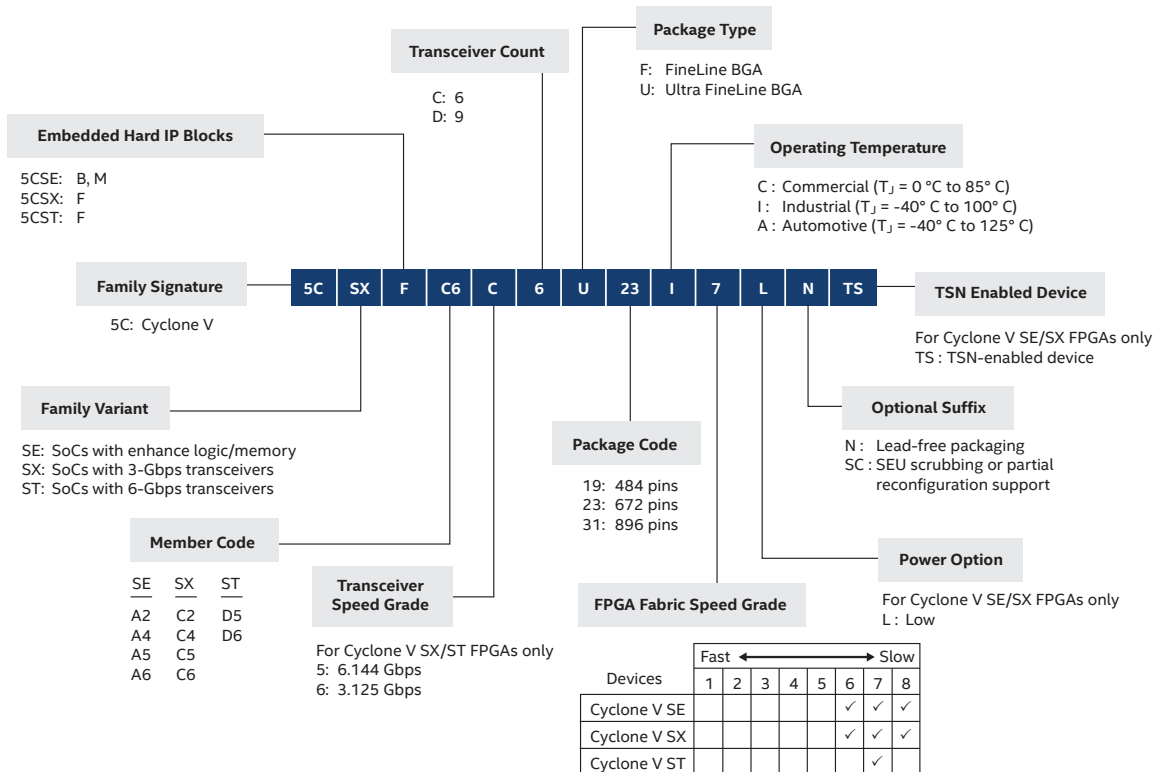

### Ordering Information for Cyclone IV GX Devices

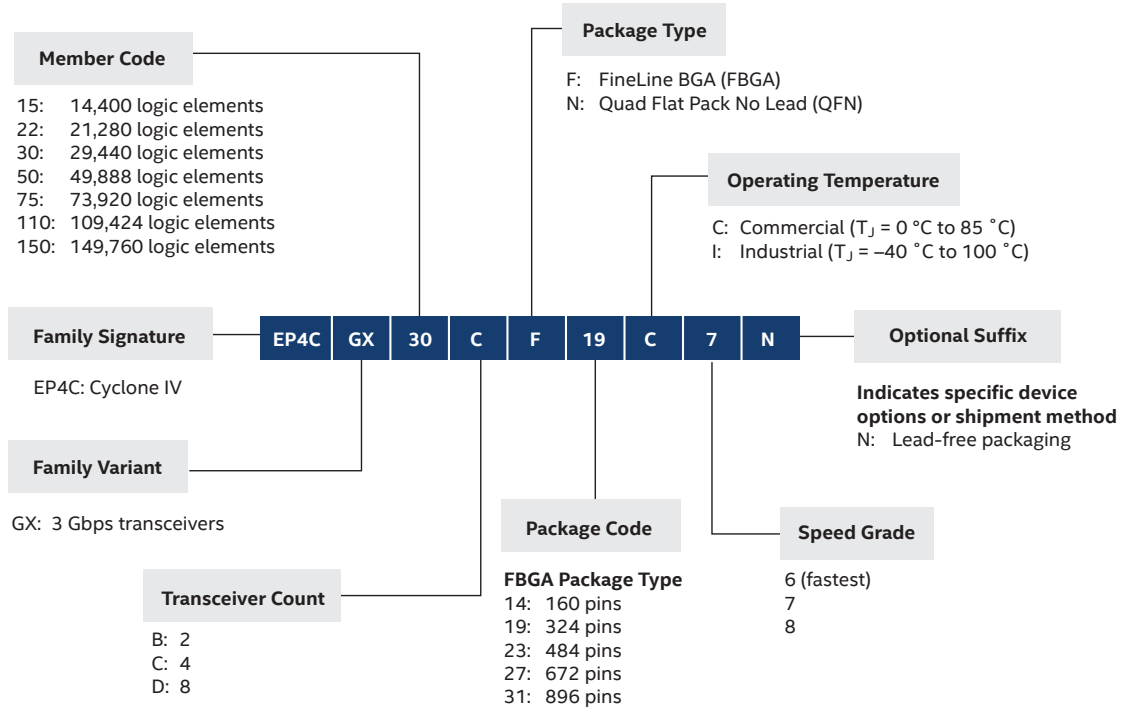

### Ordering Information for Cyclone IV E Devices

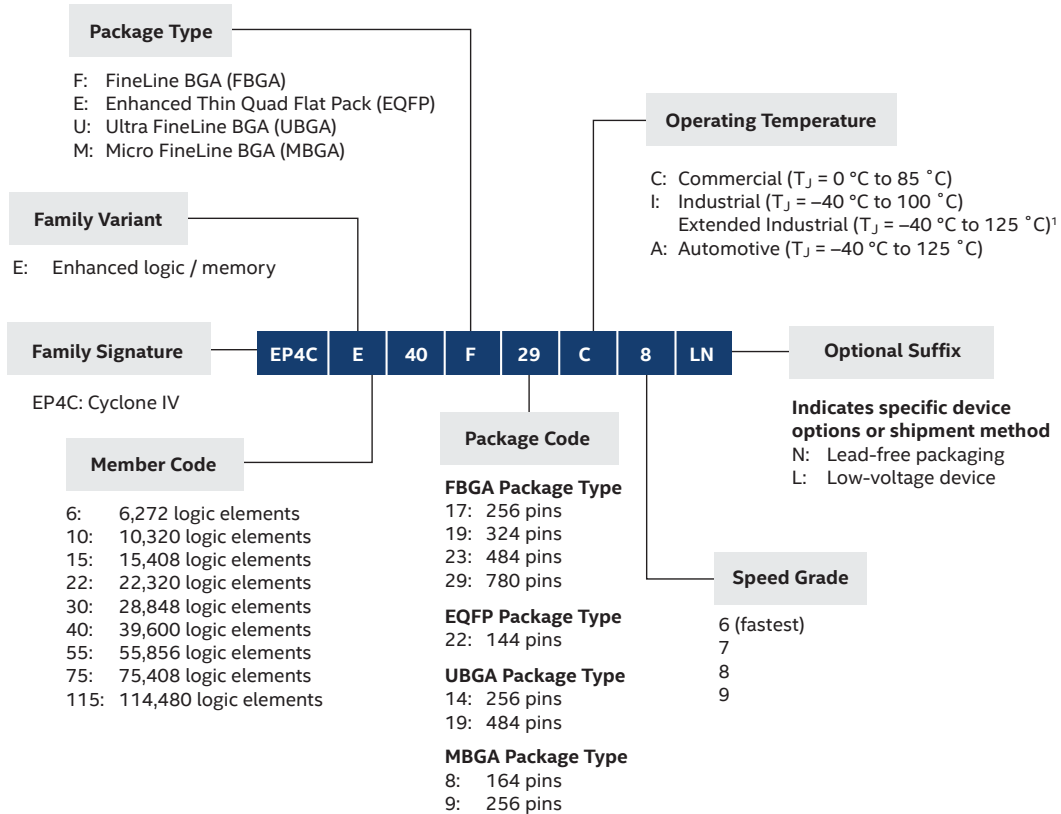

<sup>1</sup> For details, refer to the [Extended Temperature Device Support](#) web page.

### Ordering Information for MAX V Devices

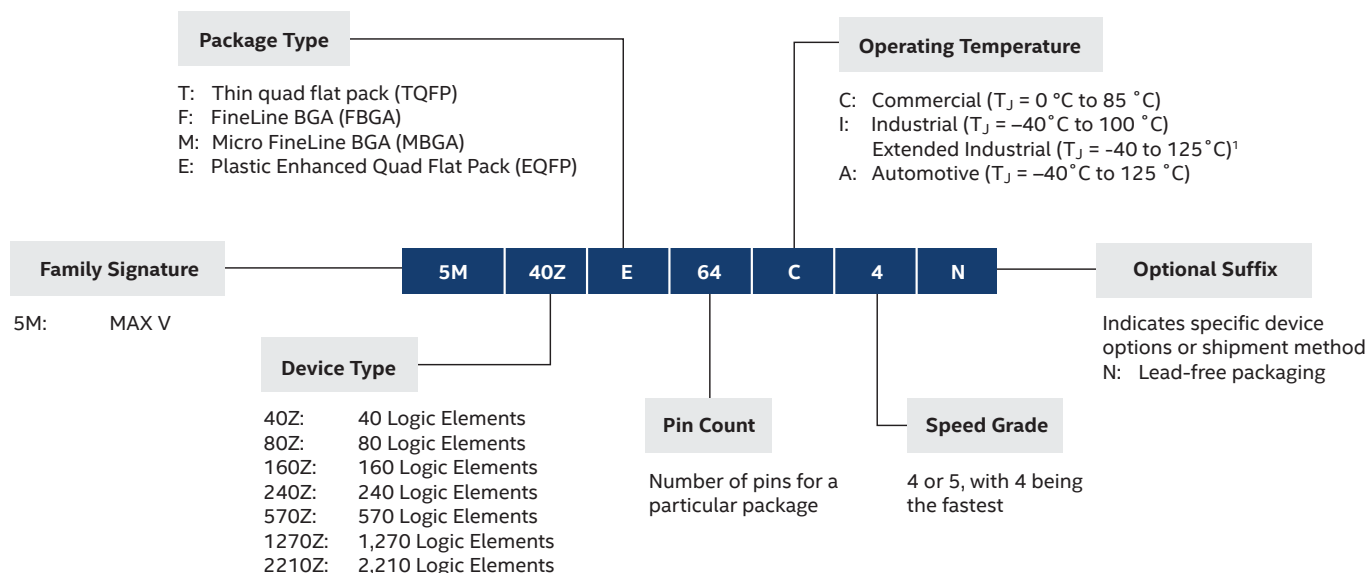

<sup>1</sup> For details, refer to the [Extended Temperature Device Support web page](#).

### Ordering Information for Serial Configuration Devices

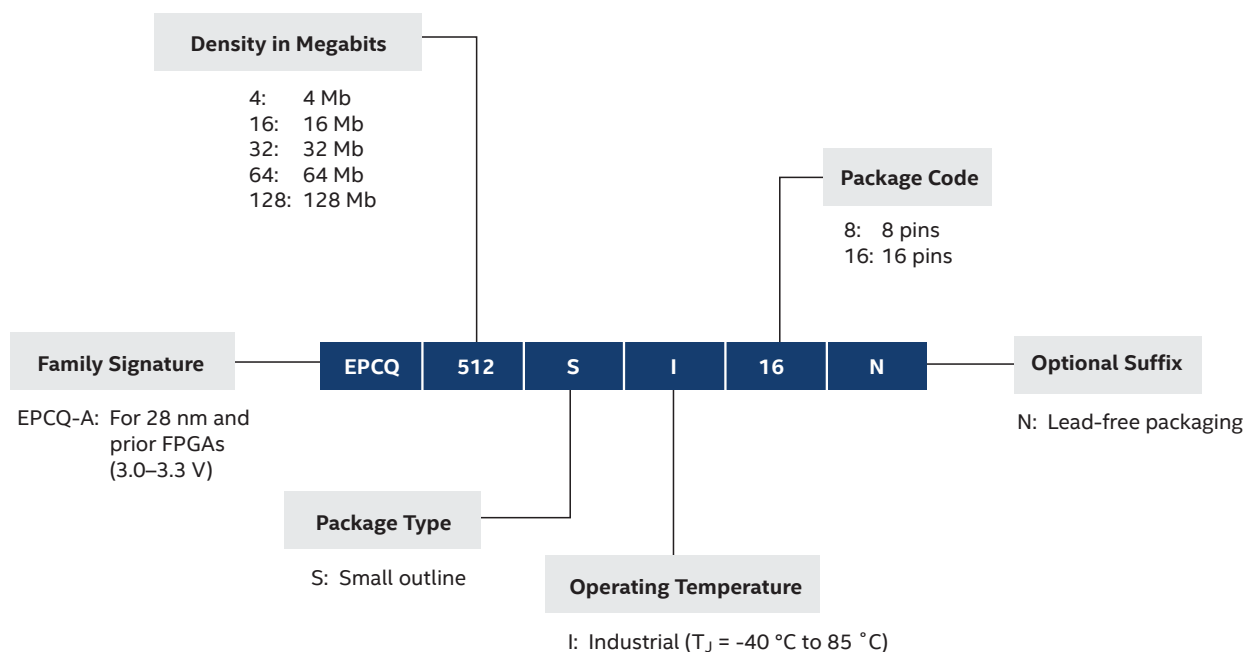



# Intel FPGA Acceleration Card Solutions

Accelerate your data center, cloud, and network infrastructure with a portfolio of Intel and partner infrastructure processing units (IPUs) and SmartNICs. These acceleration solutions are enabled by Intel's latest FPGA technology, designed, and qualified for large volume deployments. Intel, third-party, and proprietary cards such as the Silicom FPGA SmartNIC N5010 Series, Intel® FPGA SmartNIC N6000-PL Platform, and Intel® FPGA IPU F2000X-PL Platform are supported by next-generation platform software -- the Intel® Open FPGA Stack (Intel® OFS). Intel's wide portfolio of platforms, cards, and software solutions enables your workloads to be efficiently developed, scaled, and deployed.

## Intel® FPGA SmartNIC and IPU Platforms

Intel FPGA SmartNIC and IPU platforms are delivered in two ways: As Production-Ready Solutions and as a Platform Design.

Production-ready solutions can be purchased from Intel partners who offer commercial off-the-shelf production cards and solutions. Intel Open FPGA Stack (Intel OFS) and BMC design files are available from partners to accelerate workload development.

Customers who wish to accelerate their own custom board design can leverage an Intel FPGA SmartNIC or IPU Platform, consisting of board design files, Intel Open FPGA Stack, BMC design files, documentation, and a pre-production board. To get started, contact your local Intel sales representative to learn more.

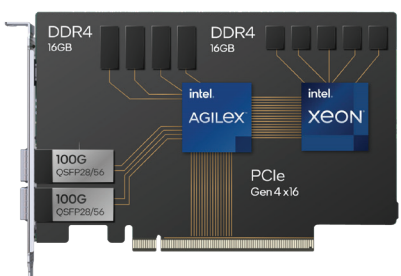

**Intel® FPGA IPU F2000X-PL Platform** is an Intel® AgileX™ FPGA-based platform for high-performance cloud acceleration. It offers 2x100 GbE network interfaces and accelerates cloud infrastructure workloads such as Open vSwitch (OvS), Non-Volatile Memory Express over Fabrics (NVMe-oF), and Remote Direct Memory Access (RDMA) over Converged Ethernet v2. Leverage FPGA programmability through Intel OFS with Infrastructure Programmer Development Kit (IPDK), Data Plane Development Kit (DPDK), or Storage Performance Development Kit (SPDK).

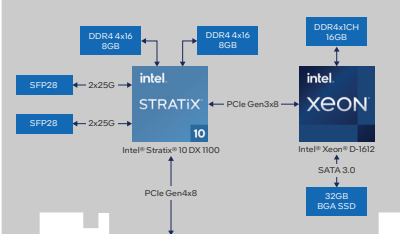

**Intel® FPGA IPU C5000X-PL Platform** is an Intel Stratix 10 FPGA and Intel Xeon processor-based cloud infrastructure acceleration platform with 2x25GbE network interfaces. Production-ready solutions are available through Silicom and Inventec.

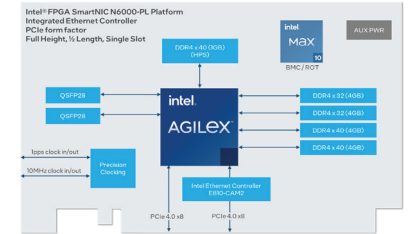

**Intel® FPGA SmartNIC N6000-PL Platform** is the 3rd generation Intel AgileX 7 FPGA family-based SmartNIC for network acceleration. It supports 2x100 Gbps Ethernet connectivity and boasts higher performance, TCO optimization, and scalability compared to previous generations. Some of the available workloads include 4G/5G Virtualized Radio Access Network (vRAN), Virtual Cell Site Router (vCSR), 5G User Plane function (UPF), Conrail 2 and SMPTE ST2110 Professional Media over Managed IP Networks.

## Partner FPGA SmartNIC and IPU Production Ready Solutions



**Silicom FPGA SmartNIC N5010** is the first hardware programmable 4x100 GbE FPGA SmartNIC enabling next-generation IA-based servers to meet the performance needs of the 4/5G Core User Plane Function/ Access Gateway Function. Its re-programmability can support Virtual Broadband Network Gateway, Virtualized Evolved Packet Core, Internet Protocol Security, vFirewall, Segment Routing Version, and Vector Packet Processing workload capability.

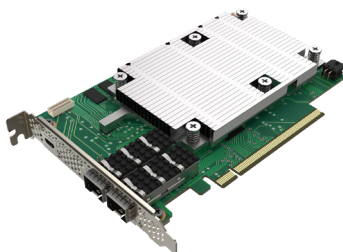

**Based on the Intel FPGA IPU C5000X-PL Platform**

**Silicom FPGA IPU C5010X and Inventec FPGA IPU C5020X adapters** are Intel® Xeon® D processor, SoC + FPGA cards offering a hardware programmable data path with 50G connectivity. With these IPUs, cloud service providers can improve server core utilization by offloading vSwitch and storage using IA-optimized DPDK and SPDK.



**Based on the Intel FPGA SmartNIC N6000-PL Platform**

**Silicom FPGA SmartNIC N6010/ N6011 and WNC FPGA SmartNIC WSN6050 series** are high-performance Intel Agilex FPGA-based SmartNICs. These platforms provide 2x100 GbE connectivity for acceleration of communication workloads such as 4G/5G Virtualized Radio Access Network (vRAN), Virtual Network Functions (VNFs), and Professional Media over Managed IP Networks.

Product descriptions and datasheets for partner SmartNIC and IPU Acceleration Platforms can be found in the [Intel® Solution Marketplace](#) or the [Silicom](#), [Inventec](#), and [WNC](#) websites, and are not located in this catalog.

### Accelerated Workload Solutions with Intel Partners

Intel has engaged with leading providers of virtual appliances and accelerator functions best suited for FPGA acceleration. These partners build pre-designed accelerator functions that integrate seamlessly into common libraries, software frameworks, and your custom software application to minimize development investment and accelerate time to market. Our partners specialize in applications from 5G, network functions virtualization (NFV), data center, and more. All you need to do is select a card, identify a workload you want to accelerate, and let our partners take the effort out of your design. As a result, you get complete solutions and design services to minimize your development investment and accelerate your time to market.

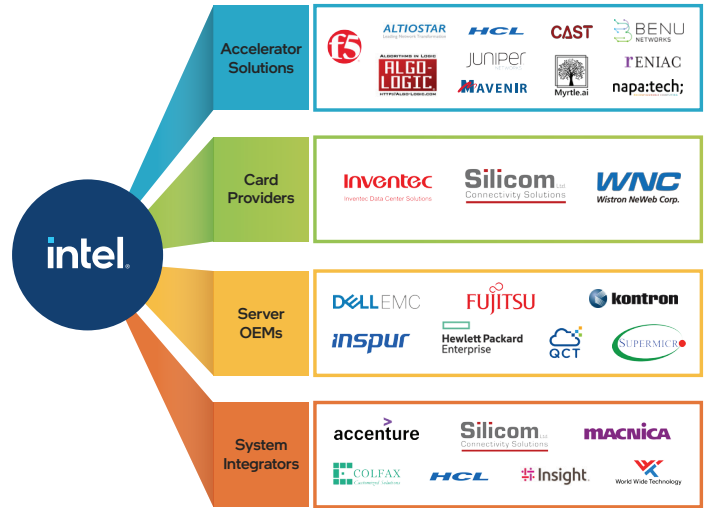







Partners listed in the figure are examples and not all partners are represented.

### Platform Software

Intel® OFS is the latest platform software enabling the customization and acceleration of Intel, third-party, or proprietary cards and platforms. Intel OFS is a scalable, source-accessible hardware and software infrastructure delivered via git repositories currently being used by Intel and select third-party platforms featuring our Intel Stratix 10 FPGA, Intel Agilex FPGA, and future Intel FPGA families. Intel OFS provides an efficient path for custom FPGA-based platform development by providing the FPGA, networking, memory, standard interfaces, board management, libraries, and more. The provided reference shell and source code can be modified to develop a unique acceleration platform or leveraged as-is for expedited development.

### Why Choose Intel FPGAs for Acceleration Applications?

 <p><b>Ease of Deployment</b></p> <p>Find validated and qualified Intel® FPGA Programmable Acceleration Cards (Intel® FPGA PACs) through several leading original equipment manufacturers (OEMs).</p>	 <p><b>Standardization</b></p> <p>Help eliminate complexity and enable application portability by leveraging the standard hardware and software interfaces provided by the Intel platform or card software.</p>	 <p><b>Wide-range of Solutions</b></p> <p>Discover what FPGAs can do for your business with the broad portfolio of acceleration solutions from technology experts.</p>
 <p><b>Customization</b></p> <p>Create customer platform or card solutions using source-accessible Intel® OFS hardware and software code.</p>	 <p><b>Faster Time to Deployment</b></p> <p>Experience faster time to deployment with native support for Intel OFS by leading open-source software distribution vendors.</p>	 <p><b>Portability</b></p> <p>Achieve greater design portability through industry-standard interface support and reusable OFS Standard APIs.</p>

# Intel Open FPGA Stack

Intel Open FPGA Stack (Intel OFS) is a scalable, source-accessible hardware and software infrastructure delivered through git repositories that enables you to customize your own unique acceleration platform or card solutions. Intel OFS provides open access to a source-accessible infrastructure, developed using an open-source methodology, with standard interfaces and APIs. Intel OFS code is developed and validated using the Intel FPGA PAC D5005 and the Intel N6000 Acceleration Development Platform (ADP) as hardware reference platforms for the Intel Stratix 10 and Intel Agilex FPGA. Users are encouraged to leverage these reference platforms for initial code bring-up before modifying and porting to custom hardware.

## Intel OFS provides multiple benefits to hardware, software, and application design engineers:

Intel® OFS Feature	Board Developer	Software Developer	Application Developer
<b>Inherit an ecosystem</b> of Intel® Open FPGA Stack-based boards, workloads, and OS distributors	✓	✓	✓
<b>Accelerate software development</b> by leveraging software drivers upstreamed to the Linux kernel and Open Programmable Acceleration Engine (OPAE) software and libraries		✓	✓
<b>Accelerate workload development</b> with industry-standard Arm AMBA AXI and Avalon compliant bus interfaces, workload examples, and simulation	✓		✓
<b>Accelerate your verification and validation</b> with automated build scripts, a United Verification Methodology (UVM) environment, and a suite of unit test cases	✓		
<b>Customize your FPGA design (FIM)</b> with modular and composable source code	✓		

## Get Started Today with Intel OFS

Contact your local Intel sales representative or complete our questionnaire on [intel.com/ofis](https://intel.com/ofis) to request access to the Intel OFS source code and documentation on GitHub. For more information on the hardware and software architecture, check out the [Intel OFS Product Brief](#).

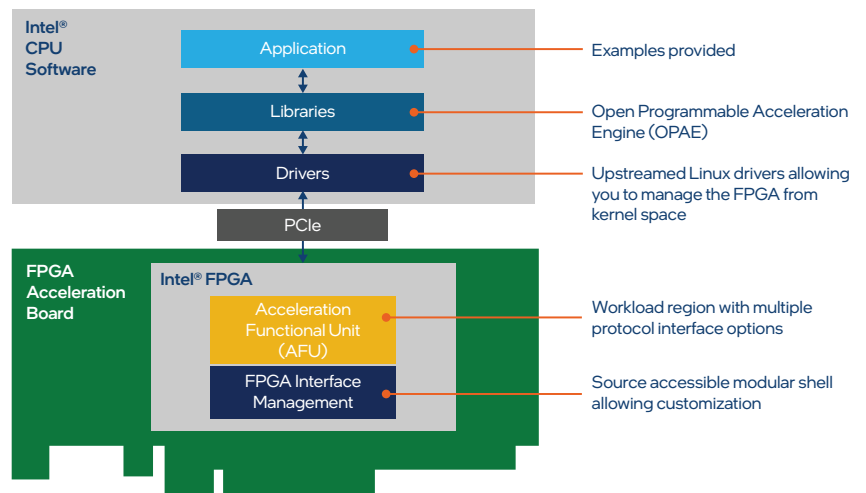

# Intel FPGA IPU F2000X-PL

The Intel FPGA IPU F2000X-PL is a high-performance Intel Agilex FPGA-based IPU platform providing networking and storage acceleration for cloud and communication service providers. The F2000X-PL offers 2x100GbE network interface and accelerates cloud workloads such as Open vSwitch, NVMe over Fabrics, and RDMA over Converged Ethernet, and has hardware crypto blocks to enhance security. It offers FPGA re-programmability through IPDK, DPDK, SPDK, and Intel OFS.

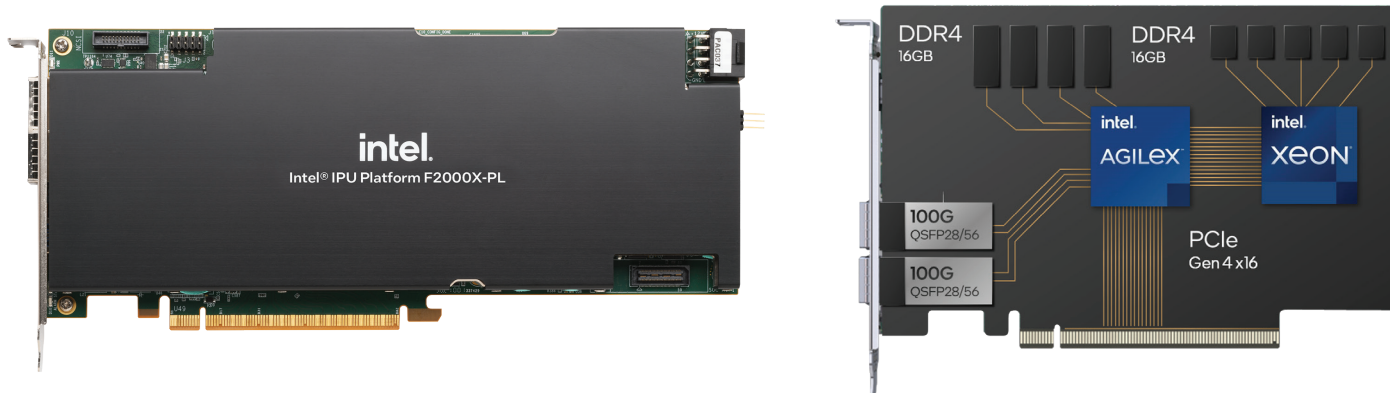

## Targeted Workloads

- Open vSwitch (OvS)
- NVMe-oF
- RDMA over Converged Ethernet v2 (RoCEv2)
- Packet processing
- Cryptographic acceleration
- Security

## Hardware

Intel Agilex 7 FPGAs F-Series

- 2,300K logic elements
- 222 Mb on-chip memory
- 3,200 DSP blocks

Onboard memory

- 16 GB DDR4 (to FPGA and processor)

Interfaces

- PCIe 4.0 x16
- 8 core Intel Xeon D processor
- 2X QSFP with up to 2x100 GbE configuration

Form factor

- ¾ length, full height; single slot

Board management

- Intel Cyclone 10 LP FPGA Board Management Controller (BMC)
  - Temperature and voltage readout Platform Level Data Model (PLDM)
- Full security implementation using Intel MAX 10 FPGA as RoT
- Remote update capabilities for FPGA flash memory and BMC

Power management

- Intelligent system power management with real-time telemetry and health monitoring

## Software

- IPDK
- DPDK
- SPDK
- OPAE
- Intel OFS
- FPGA Interface Manager

## Ordering Information

Contact an [Intel sales representative](#) for ordering information.

# Intel FPGA IPU C5000X-PL

The Intel FPGA IPU C5000X-PL Platform is a high-performance, Intel Xeon D processor and Intel Stratix 10 FPGA-based, cloud infrastructure accelerator. It supports up to 50G network connectivity and accelerates cloud and telco cloud infrastructure workloads such as Open vSwitch, NVMe over Fabrics, and RDMA over Converged Ethernet v2. Cloud service providers can take advantage of a large software ecosystem including software tools such as Virtio-net and DPDK or SPDK. Workloads can be optimized in bare metal, virtualized cloud, and bare metal virtualization deployments. The development platform is available from Intel, and production ready partner solutions are available from Silicom and Inventec.

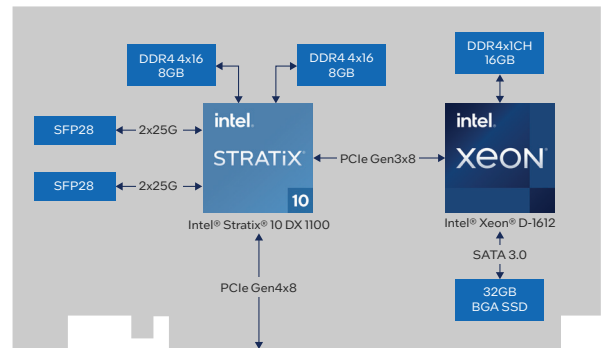
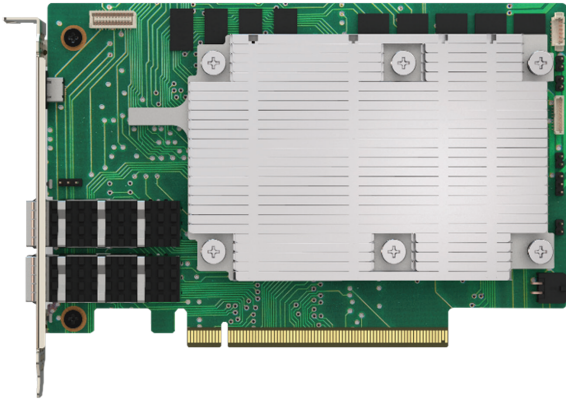

## Targeted Workloads

- Open vSwitch
- NVMe-oF
- RDMA over Converged Ethernet v2 (RoCEv2)
- Security

## Hardware

### Intel Stratix 10 DX FPGA

- 1,325K logic elements
- 114 Mb on-chip memory
- 5,184 DSP blocks

### Onboard memory

- 20 GB DDR4
- 1.25 Gb flash

### Interfaces

- PCIe 3.0 x8 or 4.0 x8
- 4-8 core Intel Xeon D processor
- Up to 2x25 GbE configuration

### Form factor/thermal/power

- 1/2 length, full height
- 75 W for key applications

### Board management

- Full security implementation using BMC as RoT
- Remote update capabilities for FPGA flash memory and BMC

### Power management

- Intelligent system power management with real-time telemetry and system health monitoring

## Software

- DPDK/BBDev
- SPDK
- OPAAE

## Design Entry Tools

- Intel Quartus Prime Pro Edition Software

## Ordering Information

Buy now from:

- [Inventec](#), [Silicom](#)

# Intel FPGA SmartNIC N6000-PL Platform

The Intel FPGA SmartNIC N6000-PL Platform is the 3rd generation Agilex 7 FPGA family-based SmartNIC for network acceleration. It supports 2x100 Gbps Ethernet connectivity and boasts higher performance, TCO optimization, and scalability compared to previous generations. Intel Agilex 7 FPGAs are built with Intel's advanced 10 nm SuperFin technology and a second-generation Intel® Hyperflex™ FPGA Architecture. Agilex 7 devices deliver ~2X better fabric performance per watt compared to competing 7 nm FPGAs.

The Intel® FPGA SmartNIC N6000-PL Platform is delivered in two ways:

**As Production-ready Solutions:** Customer who wish to deploy commercial off-the-shelf N6000 based-SmartNIC as-is, can buy N6000-based production cards and solutions from Intel's partners. Open FPGA Stack (OFS) and BMC design files are available from partners to accelerate the workload development

**As Platform Design:** Customers who wish to accelerate their own custom board design by leveraging the N6000 board design and customizing to add their own differentiation can use the Intel FPGA SmartNIC N6000-PL Platform, consisting of board design files, Open FPGA Stack (OFS) stack, BMC design files, documentation, and a pre-production board. Contact your local Intel sales representative to learn more.

**Workloads Available:** 4G/5G Virtualized Radio Access Network (vRAN), Virtual Cell Site Router (vCSR), 5G User Plane Function (UPF), Contrail2 (CN2) offload, SMPTE ST2110 Professional Media over Managed IP Networks & more. Contact Intel sales representative or Intel's partners for the workloads.

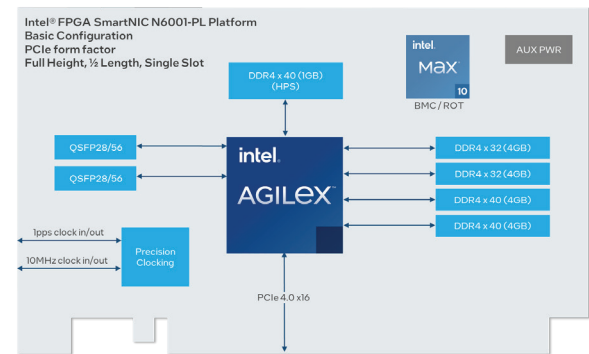
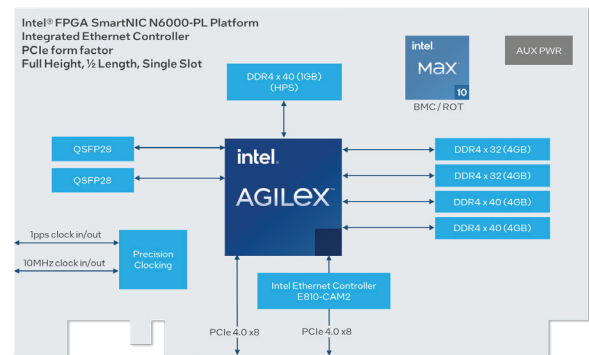

## Targeted Workloads

- vRAN/Open RAN (O-RAN)
- 5G UPF
- vCSR
- SMPTE ST2110 Professional Media over Managed IP Networks
- Contrail (CN2)

## Hardware

### Intel Agilex 7 FPGAs F-Series

- High-performance F-Series, multi-gigabit SERDES transceivers up to 58 Gbps
- 1,437K logic elements
- 190 Mb on-chip memory
- 4,510 DSP blocks

### Onboard memory

- 16 GB DDR4 to FPGA
- 1 GB DDR4 to HPS

### Interfaces

- PCIe 4.0 bifurcated x8/x8 (N6000)
- PCIe 4.0 x16 (N6001)
- Intel® Ethernet Controller E810-CAM2 (N6000)
- 2X QSFP with up to 2x100 GbE support (2x1x100G, 2x2x50G, 2x4x25G, 2x4x10G)
- Supports SyncE, CPRI, eCPRI
- Front panel SMA for IEEE1588 1pps/10 MHz and master clocking
- O-RAN LLS-C1, -C2, -C3 support

### Form factor/thermal/power

- FHHL, single slot; passively cooled
- N6000 < 100W, N6001 < 75W
- NEBS Class 1 compliance support

### Board management

- Intel MAX 10 FPGA BMC
- Full security implementation using Intel MAX 10 FPGA as RoT
- Remote update capabilities for FPGA flash memory and BMC
- Full card BMC solution host communication via SMBus and PCIe VDM

### Power management

- Intelligent system power management with real-time telemetry and system health monitoring

## Software

- DPDK
- FlexRAN/BBDEV(pf-bb-config) - only for vRAN
- OPAE
- Intel OFS

## Design Entry Tools

- Intel Quartus Prime Pro Edition Software

## Ordering Information

Production card (ready-to-deploy COTS board): Available now

Buy now from:

- Winston NeWeb Corp (WNC)
- Silicom

For Intel FPGA SmartNIC N6000-PL Platform Design (customizing board design)

- Contact Intel sales representative



# Accelerated Workload Solutions

Intel's broad ecosystem enables leading providers to offer a variety of accelerator functions best suited for FPGA acceleration. A number of these providers have complete solutions enabled for Intel FPGA-based PACs, IPUs, and SmartNICs, ranging from NFV, network security and monitoring, data analytics, AI, and more.

## VNF and NFV Infrastructure Acceleration Workloads

 <p><b>Open vSwitch (OvS)</b></p>	 <p><b>Contrail CN2 Contrail Classic</b></p>	 <p><b>Segment Routing Version (SRv6)</b></p>	
 <p><b>Virtual Application Delivery Controller (vADC)</b></p>	 <p><b>Applications Access Gateway</b></p>	 <p><b>Network Slicing</b></p>	 <p><b>L4 Server Load Balancing Acceleration</b></p>

## Wireless Application Workloads

 <p><b>Virtualized Radio Access Network (vRAN)</b></p>	 <p><b>Fronthaul Gateway (FHGW)</b></p>	 <p><b>Virtual Cell-site Router</b></p>
--	--	--

## Application Workloads for Enterprise and Cloud

 <p><b>Data Analytics</b></p>	 <p><b>Artificial Intelligence</b></p>	 <p><b>Packet Monitoring and Cyber Security</b></p>	 <p><b>Media Processing</b></p>
 <p><b>Genomics</b></p>	 <p><b>Financial Services (FSI)</b></p>	<p><a href="#">Browse Intel® Solutions Marketplace</a></p>	

Or visit the following website for various partner acceleration solutions:  
[www.intel.com/content/www/us/en/products/details/fpga/platforms.html](http://www.intel.com/content/www/us/en/products/details/fpga/platforms.html)

# Intel FPGA Acceleration Card Comparison

Features		Silicom FPGA SmartNIC N5010	Intel IPU C5000X-PL Platform	Intel FPGA SmartNIC N6000-PL Platform	Intel FPGA IPU F2000X-PL Platform
Product Category	Target Market	SmartNIC for Communications	IPU for CSP	SmartNIC for Communications	IPU for CSP
	Type	Partner card	Partner card	Intel SmartNIC Platform	Intel FPGA IPU
FPGA Resources	FPGA	Intel Stratix 10 DX	Intel Stratix 10 DX	Intel Agilex 7 FPGA F-Series	Intel Agilex 7 FPGA F-Series
	Logic Elements	2,073K	1,325K	1,437K	2,300K
	On-chip Memory	240 Mb + 8 GB (HBM2)	114 Mb	190 Mb	222 Mb
	DSP Blocks	7,920	5,184	4,510	3,200
Processor	Type	-	Intel Xeon D-1612 Processor	Quad-core 64-bit Arm Cortex-A53 Processor	8-core Intel Xeon-D SoC
Memory	DDR4	32 GB	20 GB	16 GB FPGA, 1 GB Processor	16 GB FPGA, 16 GB SoC
	SRAM	144 Mb QDR IV	-	-	-
	HBM	8 GB (2 x 4 GB)	-	-	-
	Flash	2 Gb	1.25 Gb	-	2 Gb
Interfaces and Modules	PCI Express	4.0 x16 edge connector	3.0 x8, 4.0 x8 (Option)	4.0 x8 FPGA & 4.0 x8 to E810 Ethernet controller (N6000)	4.0 x16
		4.0 x16 over cable (N5000)		4.0 x16 to FPGA (N6001)	
	Network Interface	4 x100 Gbps	2 x25 Gbps	2 x 100 Gbps	2x 100 Gbps
		Dual Intel Ethernet Controller E810 (N5000)			
	Intel MAX 10 FPGA Board Management Controller	Yes	Option	Yes	Yes
	FPGA Interface Manager	Yes	-	Yes	Yes
Mechanical, Thermal, and Power	Form Factor	Full Height, $\frac{2}{3}$ Length	Full Height, $\frac{1}{2}$ Length	Full Height, $\frac{1}{2}$ Length	Full Height, $\frac{3}{4}$ Length
		Full height, full length (N5000)			
	Width	Single slot (active cooling)	Single slot	Single slot	Single slot
Maximum Power Consumption (TDP)	194 W	36 W (FPGA) + 22/30 W (Intel Xeon D processor 4C/8C)	100 W (N6000), 75 W (N6001)	100 W	
Tools Support	Intel Open FPGA Stack (Intel OFS)	Yes	No	Yes	Yes
	Intel Quartus Prime Software	Yes	Yes	Yes	Yes
	Intel OneAPI Toolkits	TBD	No	TBD	No
	Data Plane Developer Kit (DPDK)	Yes	Yes	Yes	No
	Infrastructure Programmer Development Kit (IPDK)	No	No	No	Yes
	Storage Performance Development Kit (SPDK)	No	Yes	No	Yes
	P4 Programmable	No	No	Yes	Yes
	Intel Distribution of OpenVINO™ Toolkit	No	No	No	No
How to buy	Contact	Silicom	Inventec, Silicom	Silicom, Winston NeWeb Corporation (WNC)	Intel

# Intel Quartus Prime Design Software

[intel.com/quartus](http://intel.com/quartus)

The Intel Quartus Prime Software is revolutionary in performance and productivity for FPGA, CPLD, and SoC designs, providing a fast path to convert your concept into reality. The Intel Quartus Prime Software also supports many third-party tools for synthesis, static timing analysis, board-level simulation, signal integrity analysis, and formal verification.

Intel Quartus Prime Design Software			Availability		
			Pro Edition (\$)	Standard Edition (\$)	Lite Edition (Free)
Device Support	Intel Agilex FPGAs		✓		
	Intel Stratix series	IV, V		✓	
		10	✓		
	Intel Arria series	II			✓ <sup>1</sup>
		II, V		✓	
		10	✓	✓	
	Intel Cyclone series	IV, V		✓	✓
		10 LP		✓	✓
10 GX		✓ <sup>2</sup>			
Intel MAX series			✓	✓	
Design Flow	Partial reconfiguration		✓	✓ <sup>3</sup>	
	Block-based design		✓		
	Incremental optimization		✓		
Design Entry/Planning	IP Base Suite		✓	✓	Available for purchase
	Intel® HLS Compiler		✓	✓	✓
	Platform Designer (Standard)			✓	✓
	Platform Designer (Pro)		✓		
	Design Partition Planner		✓	✓	
	Chip Planner		✓	✓	✓
	Interface Planner		✓		
	Logic Lock regions		✓	✓	
	VHDL		✓	✓	✓
	Verilog		✓	✓	✓
	SystemVerilog		✓	✓ <sup>4</sup>	✓ <sup>4</sup>
Functional Simulation	Questa*-Intel® FPGA Starter Edition software		✓	✓	✓
	Questa-Intel FPGA Edition software		✓ <sup>5</sup>	✓ <sup>5</sup>	✓ <sup>5</sup>
Compilation (Synthesis & Place and Route)	Fitter (Place and Route)		✓	✓	✓
	Register retiming		✓	✓	
	Fractal synthesis		✓		
	Multiprocessor support		✓	✓	
Timing and Power Verification	Timing Analyzer		✓	✓	✓
	Design Space Explorer II		✓	✓	✓
	Power Analyzer		✓	✓	✓
	Power and Thermal Calculator		✓ <sup>6</sup>		
In-System Debug	Signal Tap Logic Analyzer		✓	✓	✓
	Transceiver toolkit		✓	✓	
	Intel Advanced Link Analyzer		✓	✓	
Operating System (OS) Support	Windows/Linux 64 bit support		✓	✓	✓

## Notes:

- The only Arria II FPGA supported is the EP2AGX45 device.
- The Intel Cyclone 10 GX device support is available for free in the Pro Edition software.
- Available for Cyclone V and Stratix V devices only and requires a partial reconfiguration license.
- For language support, refer to the [Verilog and SystemVerilog Synthesis Support](#) section of the Intel Quartus Prime Standard Edition User Guide.
- Requires an additional license.
- Integrated in the Intel Quartus Prime Software and available as a stand-alone tool. Only supports Intel Agilex and Intel Stratix 10 devices.

## Additional Development Tools

Tools	Description
Intel FPGA SDK for OpenCL	<ul style="list-style-type: none"> <li>No additional licenses are required.</li> <li>Supported with the Intel Quartus Prime Pro/Standard Edition Software.</li> <li>The software installation file includes the Intel Quartus Prime Pro/Standard Edition Software and the OpenCL software.</li> </ul>
Intel HLS Compiler	<ul style="list-style-type: none"> <li>No additional license required.</li> <li>Now available as a separate download.</li> <li>Supported with the Intel Quartus Prime Pro Edition Software.</li> </ul>
DSP Builder for Intel FPGAs	<ul style="list-style-type: none"> <li>Additional licenses are required.</li> <li>DSP Builder for Intel FPGAs (Advanced Blockset only) is supported with the Intel Quartus Prime Pro Edition Software for Intel Agilex, Intel Stratix 10, Intel Arria 10, and Intel Cyclone 10 GX devices.</li> </ul>
Nios II Embedded Design Suite	<ul style="list-style-type: none"> <li>No additional licenses are required.</li> <li>Supported with all editions of the Intel Quartus Prime Software.</li> <li>Includes Nios II software development tools and libraries.</li> </ul>
Intel SoC FPGA Embedded Development Suite (SoC EDS)	<ul style="list-style-type: none"> <li>Requires additional licenses for Arm* Development Studio for Intel® SoC FPGA (Arm* DS for Intel® SoC FPGA).</li> <li>The SoC EDS Standard Edition is supported with the Intel Quartus Prime Lite/Standard Edition Software and the SoC EDS Pro Edition is supported with the Intel Quartus Prime Pro Edition Software.</li> </ul>

## Intel Quartus Prime Design Software Features Summary

Interface Planner	Enables you to quickly create your I/O design using real time legality checks.
Pin planner	Eases the process of assigning and managing pin assignments for high-density and high-pin-count designs.
Platform Designer	Accelerates system development by integrating IP functions and subsystems (collection of IP functions) using a hierarchical approach and a high-performance interconnect based on a network-on-a-chip architecture.
Off-the-shelf IP cores	Lets you construct your system-level design using IP cores from Intel and from Intel's third-party IP partners.
Synthesis	Provides expanded language support for System Verilog and VHDL 2008.
Scripting support	Supports command-line operation and Tcl scripting.
Incremental optimization	Offers a faster methodology to converge to design sign-off. The traditional fitter stage is divided into finer stages for more control over the design flow.
Partial reconfiguration	Creates a physical region on the FPGA that can be reconfigured to execute different functions. Synthesize, place, route, close timing, and generate configuration bitstreams for the functions implemented in the region.
Block-based design flows	Provides flexibility of reusing timing-closed modules or design blocks across projects and teams.
Intel Hyperflex FPGA Architecture	Provides increased core performance and power efficiency for Intel Stratix 10 devices.
Physical synthesis	Uses post placement and routing delay knowledge of a design to improve performance.
Design space explorer (DSE)	Increases performance by automatically iterating through combinations of Intel Quartus Prime Software settings to find optimal results.
Extensive cross-probing	Provides support for cross-probing between verification tools and design source files.
Optimization advisors	Provides design-specific advice to improve performance, resource usage, and power consumption.
Chip planner	Reduces verification time while maintaining timing closure by enabling small, post-placement and routing design changes to be implemented in minutes.
Timing Analyzer	Provides native Synopsys Design Constraint (SDC) support and allows you to create, manage, and analyze complex timing constraints and quickly perform advanced timing verification.
Signal Tap logic analyzer	Supports the most channels, fastest clock speeds, largest sample depths, and most advanced triggering capabilities available in an embedded logic analyzer.
System Console	Enables you to easily debug your FPGA in real time using read and write transactions. It also enables you to quickly create a GUI to help monitor and send data into your FPGA.
Power Analyzer	Enables you to analyze and optimize both dynamic and static power consumption accurately.
Design Assistant	A design rules checking tool that allows you to get to design closure faster by reducing the number of iterations needed and by enabling faster iterations with targeted guidance provided by the tool at various stages of compilation.
Fractal synthesis	Enables the Intel Quartus Prime Software to efficiently pack arithmetic operations in the FPGA's logic resources resulting in significantly improved performance.
EDA partners	Offers EDA software support for synthesis, functional and timing simulation, static timing analysis, board-level simulation, signal integrity analysis, and formal verification. To see a complete list of partners, visit <a href="http://intel.com/fpgaedapartners">intel.com/fpgaedapartners</a> .

## Getting Started Steps

- Step 1: Download the free Intel Quartus Prime Lite Edition Software  
[intel.com/quartus](https://www.intel.com/quartus)
- Step 2: Get oriented with the Intel Quartus Prime Software interactive tutorial.  
 After installation, open the interactive tutorial on the welcome screen.
- Step 3: Sign up for training  
[intel.com/fpgatraining](https://www.intel.com/fpgatraining)

Purchase the Intel Quartus Prime Software and increase your productivity today.

### Intel Quartus Prime Software

Intel Quartus Prime Software (Standard and Pro Edition) and Questa\*-Intel® FPGA Edition software are bundled together into one single ordering part number effective October 15, 2021.

SW-ONE-QUARTUS Price: \$3,645

The purchase can be applied for Fixed or Floating or Renewal licenses.

Refer to the following product advisories for more information:

- [ADV 2127 Single Ordering Part Number for Intel Quartus Prime Software](#)

Questa-Intel FPGA Edition Software	Questa-Intel FPGA Starter Edition Software
SW-QUESTA-PLUS	SW-QUESTA
\$1,995	Free
Questa-Intel FPGA Edition software is available for \$1,995	Questa-Intel FPGA Starter Edition is available for free, but requires a license that can be generated at the Self-Service Licensing Center. It is 40% the performance of the Questa-Intel FPGA Edition software.

- Refer to the following product advisories for more information:
- [ADV 2122 Replacement of ModelSim\\*-Intel® FPGA Edition Software](#)

# DSP Builder for Intel FPGAs

[intel.com/dspbuilder](https://intel.com/dspbuilder)

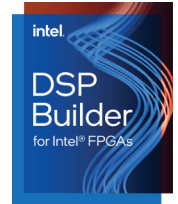

The DSP Builder for Intel FPGAs is a DSP development tool that allows push-button HDL generation of DSP algorithms directly from the MathWorks Simulink environment. This tool adds additional libraries alongside existing Simulink libraries with the DSP Builder for Intel FPGAs (Advanced Blockset) and DSP Builder for Intel FPGAs (Standard Blockset). Intel recommends using the DSP Builder for Intel FPGAs (Advanced Blockset) for new designs. The DSP Builder for Intel FPGAs (Standard Blockset) is not recommended for new designs except as a wrapper for the DSP Builder for Intel FPGAs (Advanced Blockset).

## DSP Builder for Intel FPGAs Features

The DSP Builder for Intel FPGAs (Advanced Blockset) offers the following features:

- Arithmetic logic unit (ALU) folding to build custom ALU processor architectures from a flat data-rate design
- High-level synthesis optimizations, auto-pipeline insertion and balancing, and targeted hardware mapping
- High-performance fixed- and floating-point DSP with vector processing
- Auto memory mapping
- Single system clock datapath
- Flexible 'white-box' fast Fourier transform (FFT) toolkit with an open hierarchy of libraries and blocks for users to build custom FFTs

Generate resource utilization tables for all designs without the Intel Quartus Prime Software compile.

Automatically generate projects or scripts for the Intel Quartus Prime Software, the Questa\*-Intel FPGA software, Timing Analyzer, and Platform Designer.

Features	DSP Builder for Intel FPGAs (Standard Blockset)	DSP Builder for Intel FPGAs (Advanced Blockset)
High-level optimization		✓
Auto pipeline insertion		✓
Floating-point blocks		✓
Resource sharing		✓
IP-level blocks	✓	✓
Low-level blocks	✓	✓
System integration	✓	✓
Hardware co-simulation	✓	✓

Purchase the DSP Builder for Intel FPGAs to meet high-performance DSP design needs today.

Pricing	Operating System
\$1,995 Primary \$1,995 Renewal Subscription for one year	Windows/ Linux

## Getting Started with the DSP Builder for Intel FPGAs

- Step 1: Download the Intel Quartus Prime Pro or Standard Edition Software ([intel.com/quartus](https://intel.com/quartus)):
  - [Pro Edition](#) to target the latest Intel Agilex, Intel Stratix 10, Intel Arria 10, and Intel Cyclone 10 GX devices.
  - [Standard Edition](#) to target Intel Arria 10, Intel Cyclone 10 LP, Intel MAX 10, Stratix V, and Cyclone V devices.
- Step 2: Purchase additional DSP Builder for Intel FPGAs and MATLAB software licenses:
  - [DSP Builder for Intel FPGAs software license](#)
  - [MATLAB software license](#)
- Step 3: Follow the following required order of installation:
  - a. Intel Quartus Prime Software
  - b. MathWorks MATLAB software
  - c. DSP Builder for Intel FPGAs
- Step 4: To view the DSP Builder for Intel FPGAs version history and software requirements, visit the [DSP Builder for Intel FPGAs Version History and Software Requirements](#) web page.
- Step 5: To learn how to add your DSP Builder for Intel FPGAs license to your MATLAB installation, refer to the [Installing and Licensing DSP Builder for Intel FPGAs](#) web page.

# Intel FPGA SDK for OpenCL

[intel.com/opencl](https://intel.com/opencl)



Intel FPGA SDK for OpenCL<sup>1</sup> allows you to accelerate applications on FPGAs by abstracting away the complexities of FPGA design. Software programmers can write hardware-accelerated kernel functions in OpenCL that is an ANSI C-based language with additional OpenCL constructs

to extract parallelism and program heterogeneous platforms. FPGAs are the accelerator of choice for heterogeneous systems, providing low latency, performance, and power efficiency versus GPUs and CPUs.

## Intel FPGA SDK for OpenCL Software Features Summary

Offline Compiler	<ul style="list-style-type: none"> <li>• GCC-based model compiler of OpenCL kernel code</li> </ul>
OpenCL Utility	<ul style="list-style-type: none"> <li>• Diagnostics for board installation</li> <li>• Flash or program FPGA image</li> <li>• Install board drivers (typically PCI Express)</li> </ul>
Intel Code Builder for OpenCL API	<ul style="list-style-type: none"> <li>• Edit, build, and debug OpenCL kernels</li> <li>• Collect runtime performance</li> <li>• View generated reports</li> </ul>
Operating System	<ul style="list-style-type: none"> <li>• Microsoft Windows 10</li> <li>• Red Hat Enterprise Linux 6</li> <li>• Red Hat Enterprise Linux 7</li> <li>• SUSE SLE 12</li> <li>• Ubuntu 14.04 LTS</li> <li>• Ubuntu 16.04 LTS</li> <li>• Ubuntu 18.04 LTS</li> </ul>
Memory Requirements	<ul style="list-style-type: none"> <li>• Computer equipped with at least 32 GB RAM</li> </ul>

OpenCL™ and the OpenCL logo are trademarks of Apple Inc. used by permission by Khronos.

Notes:  
1. Product is based on a published Khronos Specification, and has passed the Khronos Conformance Testing Process. Current conformance status can be found at [khronos.org/conformance](https://khronos.org/conformance).

## Getting Started with the Intel FPGA SDK for OpenCL

**Step 1:** Download the [Intel Quartus Prime Pro Edition Software](#) to target the latest Intel Agilex, Intel Stratix 10, Intel Arria 10, and Intel Cyclone 10 devices.

**Note:** The software installation file includes the OpenCL software and Intel Quartus Prime Pro Edition Software. The Intel Quartus Prime Software requires a license purchase but no additional licenses are required for the Intel FPGA SDK for OpenCL.

**Step 2:** Download the Intel Board Support Package (BSP) that is needed to run your OpenCL application. You can also [purchase a partner provided BSP](#), or [create a custom BSP](#).

**Step 3:** For more information, read the [Intel FPGA SDK for OpenCL Getting Started Guide](#).

# Embedded Software and Tools for Intel SoC FPGA

[intel.com/soceds](https://intel.com/soceds)

The Intel SoC FPGA Embedded Development Suite (SoC EDS) is a comprehensive tool suite for embedded software development on Intel SoC FPGAs. It comprises development tools, utility programs, and design examples to jump-start firmware and application software development. The SoC EDS is available in Standard and Pro Editions. The Standard Edition includes extensive support for 28 nm SoC FPGA families, whereas the Pro Edition is optimized to support the advanced features in the next-generation SoC FPGA families. In addition, the SoC EDS works in conjunction with the Arm Development Studio for Intel SoC FPGA (Arm DS for Intel SoC FPGA). This toolkit enables embedded developers to code, build, debug, and optimize in a single Eclipse-based IDE. The Arm DS for Intel SoC FPGA licenses are available in two options: a 30-day evaluation license and a paid Arm DS for Intel SoC FPGA license. The Arm DS for Intel SoC FPGA license is included at no cost with Intel SoC FPGA Development Kits.

## Intel SoC FPGA Embedded Development Suite

Key Features		Availability			
		Standard		Pro	
		Evaluation License	Paid License	Evaluation License	Paid License
Supported Device Families	Cyclone V SoC	✓	✓		
	Arria V SoC	✓	✓		
	Intel Arria 10 SoC	✓	✓	✓	✓
	Intel Stratix 10 SoC			✓	✓
	Intel Agilex SoC			✓	✓
Compiler Tools	Linaro Compiler <sup>1</sup>	✓	✓	✓	✓
	Arm Compiler 5 (included in the Arm DS for Intel SoC FPGA)		✓		
	Arm Compiler 6 (included in the Arm DS for Intel SoC FPGA)		✓		✓
Libraries	Hardware Libraries (HWLIBs)	✓	✓	✓	✓
	Quartus Prime Programmer	✓	✓	✓	✓
Other Tools	Signal Tap Logic Analyzer	✓	✓	✓	✓
	Intel FPGA Boot Disk Utility	✓	✓	✓	✓
	Device Tree Generator	✓	✓	✓	✓
Design Examples	Golden Hardware Reference Design (GHRD) for SoC development kits	✓	✓	✓	✓
	Triple-Speed Ethernet (TSE) with Modular Scatter-Gather Direct Memory Access (mSG-DMA) <sup>2</sup>	✓	✓	✓	✓
	PCI Express Root Port with Message Signal Interrupts (MSI) <sup>2</sup>	✓	✓	✓	✓
	Partial Reconfiguration design example <sup>3</sup>			✓	✓
Host OS Support	Windows 7 64 bit	✓	✓	✓	✓
	Windows 10 64 bit	✓	✓	✓	✓
	Red Hat Linux 6 64 bit	32 bit libraries are required	32 bit libraries are required	32 bit libraries are required	32 bit libraries are required
Ubuntu 18		✓	✓	✓	✓

## Arm Development Studio for Intel SoC FPGA

Arm DS for Intel SoC FPGA	Linux application debugging over Ethernet	✓	✓	✓	✓
	Debugging over Intel FPGA Download Cable II				
	<ul style="list-style-type: none"> <li>Board bring-up</li> <li>Device driver development</li> <li>Operating system (OS) porting</li> <li>Bare-metal programming</li> <li>Arm CoreSight trace support</li> </ul>		✓		✓
	Debugging over DSTREAM <ul style="list-style-type: none"> <li>Board bring-up</li> <li>Device driver development</li> <li>OS porting</li> <li>Bare-metal programming</li> <li>Arm CoreSight trace support</li> </ul>		✓		✓
	FPGA-adaptive debugging <ul style="list-style-type: none"> <li>Auto peripheral register discovery</li> <li>Cross-triggering between CPU and FPGA domains</li> <li>Arm CoreSight trace support</li> <li>Access to System Trace Module (STM) events</li> </ul>		✓		✓
	Streamline Performance Analyzer support	Limited	✓	Limited	✓

### Notes:

1. You have to download the Linaro Compiler.

2. These design examples are only available through [Rocketboards.org](https://Rocketboards.org).

3. For Intel Arria 10 SoC only.

4. Individual components of SoC EDS can now be downloaded from GitHub.

5. Intel has migrated to Arm DS for Intel SoC FPGA. Arm DS for Intel SoC FPGA is no longer a part of SoC EDS and is a separate download from [intel.com](https://intel.com).



# SoC FPGA Operating System Support

Intel and our ecosystem partners offer comprehensive operating system support for Intel SoC FPGA development boards that support the Arm Cortex-A9 processor.

Operating System	Company
Abassi	Code Time Technologies
Android	MRA Digital
AUTOSAR MCAL	Intel
Bare-Metal/Hardware Libraries	Intel
Carrier Grade Edition 7 (CGE7)	MontaVista
DEOS	DDC-I
eCosPro	eCosCentric
eT-Kernel	eSOL
FreeRTOS	FreeRTOS.org
INTEGRITY RTOS	Green Hills Software
Linux	Open Source ( <a href="http://rocketboards.org">rocketboards.org</a> )
Nucleus	Mentor Graphics

Operating System	Company
OSE	Enea
PikeOS	Sysgo
QNX Neutrino	QNX
RTEMS	RTEMS.org
RTXC	Quadros System
ThreadX	Express Logic
uC/OS-II, uC/OS-III	Micrium
uC3 (Japanese)	eForce
VxWorks	Wind River
Wind River Linux	Wind River
Windows Embedded Compact 7	Microsoft (Witekio)

## More Information

For the latest on OS support for Intel SoCs, visit [intel.com/socecosystem](http://intel.com/socecosystem)

# Nios® V Processor

The Nios® V processor is the next-generation soft processor for Intel FPGAs based on the open-source industry standard RISC-V instruction set architecture (ISA). This processor is available in the Intel Quartus Prime Pro Edition Software starting with version 21.3. The first core in the Nios V processor series is the Nios V/m microcontroller. The second core available starting with version 23.1 is the Nios V/g general purpose processor. The future Nios V core will be a 64-bit application class core that will also be linux-capable. You can use the Nios V processor together with the Arm processor in Intel SoCs to create effective multi-processor systems.

With the Nios V processor you can:

- Lower overall system cost and complexity by integrating external processors into the FPGA.
- Target the Intel Agilex, Intel Stratix, Intel Arria, Intel Cyclone, or Intel MAX 10 FPGA, or the FPGA portion of the Intel Agilex, Intel Stratix 10, Intel Arria 10, Arria V, or Cyclone V SoC.
- Leverage the community-maintained ecosystem to get your designs to market faster by choosing from the most up-to-date and modern toolchains, debuggers, and real-time operating system (RTOS) for your software development
- Take advantage of the free license for the Nios V/m microcontroller core to get started today

## Hardware development

- Intel Quartus Prime Pro Edition Software
- Platform Designer
- Signal Tap logic analyzer
- System Console for low-level debugging of Platform Designer systems

## Software development

- Software development and debug is supported using the RiscFree\* IDE for Intel® FPGAs. This integrated development environment (IDE) includes the full toolchain, IDE, compiler, debugger, and trace support.
- You can also use third party tools of your choice from the open-source ecosystem that work with RISC-V processors

## Licensing

A license is required for Nios V processors. The Nios V/m embedded processor license is available at no cost in the [Self-Service Licensing Center](#).

## Getting started

To learn more about the Nios V processor, visit [www.intel.com/content/www/us/en/products/details/fpga/nios-processor/v.html](http://www.intel.com/content/www/us/en/products/details/fpga/nios-processor/v.html)

# RiscFree\* IDE for Intel® FPGAs

The RiscFree\* IDE for Intel® FPGAs is developed by Ashling for Intel® FPGAs. This integrated development environment (IDE) provides software development and debug support for Nios V processors that are based on the RISC-V ISA. It includes the full toolchain, IDE, compiler, and debugger.

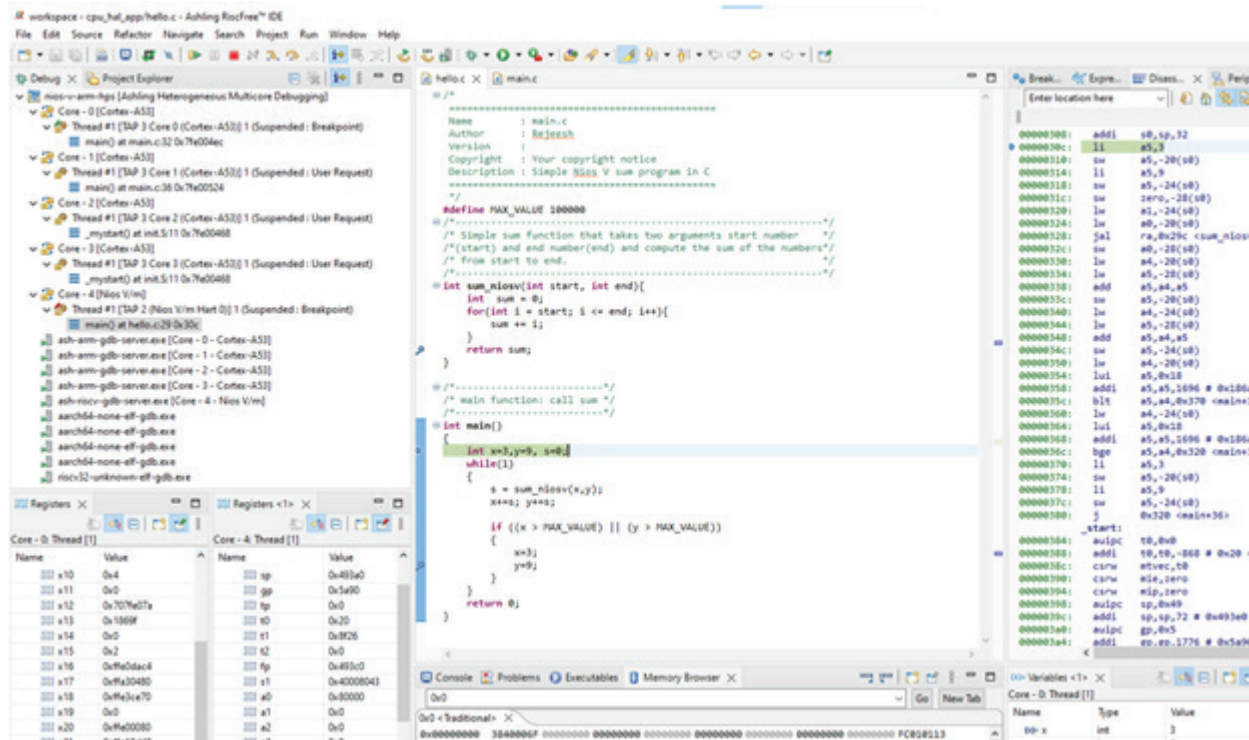

## What you get with RiscFree\* IDE with Intel Quartus Prime Software v23.1

- Single-shot free stand-alone installer that works out-of-the-box or integrated with the Intel Quartus Prime Software
- Support for Intel Agilex, Intel Stratix, Intel Arria, Intel Cyclone, or Intel MAX 10 FPGA, or the FPGA portion of the Intel Agilex, Intel Stratix 10, Intel Arria 10, Arria V, or Cyclone V SoC.
- Project Manager and Build Manager including Make and CMake support with rapid import, build, and debug of Intel Quartus software-created applications
- Targeted Nios V GCC compiler toolchain fully integrated into the RiscFree\* IDE with support for newlib and picolibc runtime libraries using the Nios V Hardware Abstraction Layer (HAL) application programming interface (API) for hardware access
- Runtime debug with support for the Intel® FPGA Download Cable II
- Homogeneous and heterogeneous simultaneous multi-core debug support for Nios V and Arm processor cores
- Register visualization for Arm processor cores
- uC/OS-II, Zephyr, and FreeRTOS real time operating system debug awareness

## Hardware Development Tools

- Intel Quartus Prime Pro Edition Software
- Platform Designer
- Signal Tap logic analyzer
- System Console for low-level debugging of Platform Designer systems

## Get Started

The RiscFree\* IDE for Intel® FPGAs can be downloaded at [FPGA Software Download Center](#) as a stand-alone installer or as part of the Intel Quartus Prime Pro Edition Software download. To learn more about the Nios V processor and the RiscFree\* IDE for Intel® FPGAs, visit [intel.com/content/www/us/en/products/details/fpga/nios-processor/v.html](https://www.intel.com/content/www/us/en/products/details/fpga/nios-processor/v.html).

# Nios<sup>®</sup> II Processor

In any Intel FPGA, the Nios<sup>®</sup> II processor offers a custom system solution that has the flexibility of software and the performance of hardware. Through its innovative design, the Nios II processor leverages the logic resources of the device to provide unprecedented hard and soft real-time capabilities.

You can also use the Nios II processor together with the Arm processor in Intel SoCs to create effective multi-processor systems.

With the Nios II processor you can:

- Lower overall system cost and complexity by integrating external processors into the FPGA.
- Scale performance with multiple processors, custom instructions (hardware acceleration of a software function), or co-processor modules (hardware accelerator next to the soft processor).
- Target the Intel Agilex, Intel Stratix, Intel Arria, Intel Cyclone, or Intel MAX 10 FPGA, or the FPGA portion of the Intel Agilex, Intel Stratix 10, Intel Arria 10, Arria V, or Cyclone V SoC.
- Eliminate the risk of processor and ASSP device obsolescence.
- Take advantage of the free Nios II economy core, and the free Nios II Embedded Design Suite (EDS), to get started today.

## Nios II Processor Development Flow

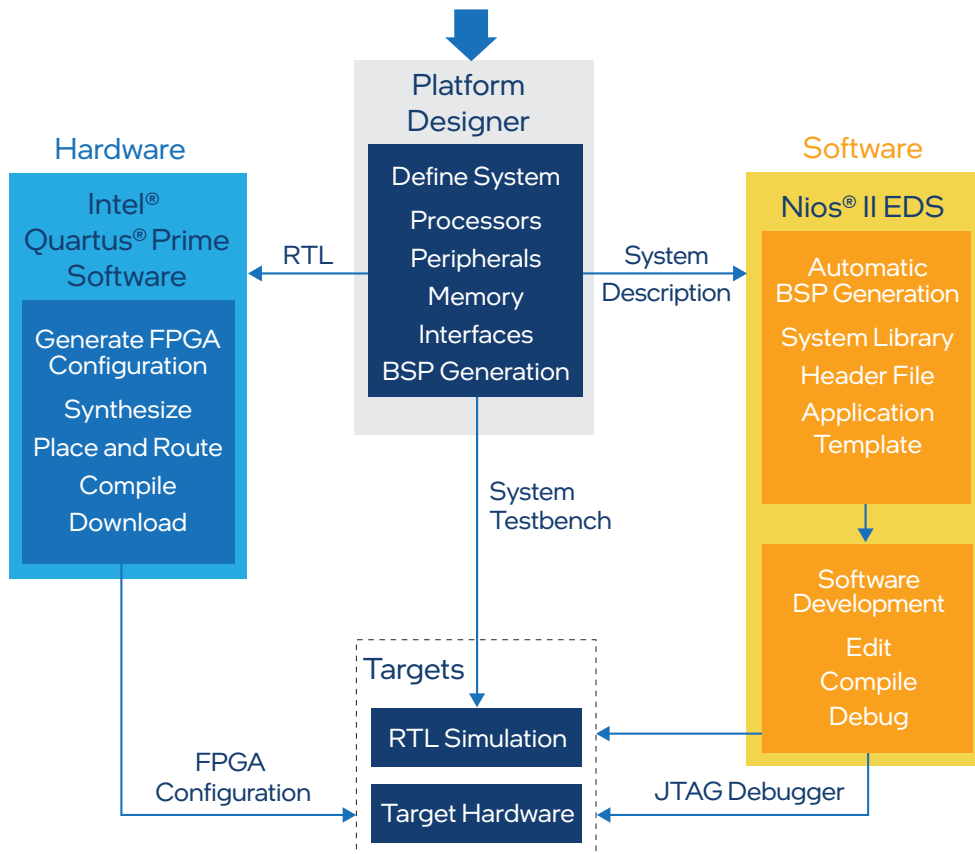

# Nios II Processor Embedded Design Suite

The Nios II processor, the world's most versatile processor according to Gartner Research, is the most widely used soft processor in the FPGA industry. This soft processor delivers unprecedented flexibility for your cost-sensitive, real-time, safety-critical (DO-254), and applications processing needs. All Intel FPGA families support the Nios II processor.

---

## Nios II EDS Contents

---

Nios II Software Build Tools for Eclipse (Nios II SBT for Eclipse) for software development

- Based on Eclipse IDE
- New project wizards
- Software templates
- Source navigator and editor

---

Compiler for C and C++ (GNU)

---

Software Debugger/Profiler

---

Flash Programmer

---

Embedded Software

- Hardware Abstraction Layer (HAL)
- MicroC/OS-II RTOS (full evaluation version)
- Newlib ANSI-C standard library
- Simple file system

---

Other Intel Command-Line Tools and Utilities

---

Design Examples

---

## Hardware Development Tools

- Intel Quartus Prime Standard and Pro Edition Software
- Platform Designer
- Signal Tap logic analyzer plug-in for the Nios II processor
- System Console for low-level debugging of Platform Designer systems

## Licensing

Getting started with the Nios II processor is now easier than ever. Not only is the Nios II EDS free, but the Nios II economy core IP is also free.

Licenses for the Nios II fast core IP are available stand-alone (IP-NIOS) or as part of the Embedded IP Suite (IPS-EMBEDDED). The Embedded IP Suite is a value bundle that contains licenses for the Nios II processor IP core, DDR1/2/3 Memory Controller IP cores, Triple-Speed Ethernet MAC IP core and 16550 - compatible UART IP core. These licenses support both Nios II Classic and Gen2 processors. These royalty-free licenses never expire and allow you to target your processor design to any Intel FPGA.

## Nios II EDS: What You Get for Free!

The Nios II Embedded Design Suite (EDS) provides all the tools and software you need to develop code for the Nios II processor.

With the Nios II EDS you can:

- **Develop software with Nios II SBT for Eclipse:**  
Based on industry-standard Eclipse, the Nios II SBT is an integrated development environment for editing, compiling, debugging software code, and flash programming.
- **Manage board support packages (BSPs):**  
The Nios II EDS makes managing your BSP easier than ever. The Nios II EDS automatically adds device drivers for Intel FPGA-provided IP to your BSP, and the BSP Editor provides full control over your build options.
- **Evaluate a RTOS:**  
The Nios II EDS contains an evaluation version of the popular Micrium MicroC/OS-II RTOS. Product licenses can be purchased directly from Micrium.

## Join the Nios II Processor Community!

Be one of many Nios II processor developers who visit the Intel FPGA Wiki, Intel FPGA Community, and the [Rocketboards.org](http://Rocketboards.org) website. Intel FPGA Wiki and the [Rocketboards.org](http://Rocketboards.org) website have hundreds of design examples and design tips from Nios II processor developers all over the world. Join ongoing discussions on the Nios II processor section of the Intel FPGA Community to learn more about Linux, hardware, and software development for the Nios II processor.

Visit the following websites:

[community.intel.com](http://community.intel.com)  
[forums.intel.com](http://forums.intel.com)  
[rocketboards.org](http://rocketboards.org)  
[FPGA Design Store](http://FPGA Design Store)

## Development Kits

Go to [page 88](#) for information about embedded development kits.

# Nios II Processor Operating System Support

Intel and our ecosystem partners offer comprehensive operating system support for the Nios II processor.

OS	Availability
ChibiOS/RT	Now through <a href="http://emb4fun.com">emb4fun.com</a>
eCos	Now through <a href="http://ecoscentric.com">ecoscentric.com</a>
eCos (Zylin)	Now through <a href="http://opensource.zylin.com">opensource.zylin.com</a>
embOS	Now through <a href="http://segger.com">segger.com</a>
EUROS	Now through <a href="http://euros-embedded.com">euros-embedded.com</a>
FreeRTOS	Now through <a href="http://freertos.org">freertos.org</a>
Linux	Now through <a href="http://windriver.com">windriver.com</a>
Linux	Now through <a href="http://rocketboards.org">rocketboards.org</a>
oSCAN	Now through <a href="http://vector.com">vector.com</a>
TargetOS	Now through <a href="http://blunkmicro.com">blunkmicro.com</a>
ThreadX	Now through <a href="http://threadx.com">threadx.com</a>
Toppers	Now through <a href="http://toppers.jp">toppers.jp</a>
µC/OS-II, µC/OS-III	Now through <a href="http://micrium.com">micrium.com</a>
Zephyr	Now through <a href="http://zephyrproject.org">zephyrproject.org</a>

## Summary of Soft Processors

Category	Processor	Vendor	Description
Performance-optimized processing	Nios V microcontroller core	Intel	Based on <a href="#">RISC-V: RV32IA</a> . Nios V processors give you the ultimate flexibility to achieve the exact performance required for your embedded design, without overpaying for high clock frequency, power-hungry off-the-shelf processors. Due to architectural improvements, the Nios V processor has performance benefits over the Nios II processor.
Power- and cost-optimized processing	Nios II economy core	Intel	With unique, real-time hardware features such as custom instructions, ability to use FPGA hardware to accelerate a function, vectored interrupt controller, and tightly coupled memory, as well as support for industry-leading RTOSs, the Nios II processor meets both your hard and soft real-time requirements, and offers a versatile solution for real-time processing.
Real-time processing	Nios II fast core <sup>1</sup>	Intel	
Applications processing	Nios II fast core	Intel	A simple configuration option adds a memory management unit to the Nios II fast processor core to support embedded Linux. Both open-source and commercially supported versions of Linux for Nios II processors are available.
Safety-critical processing	Nios II SC	HCELL	Certify your design for DO-254 compliance by using the Nios II Safety Critical core along with the DO-254 compliance design services offered by HCELL.
Lockstep Solution	Nios II Lockstep dual core	Intel	Provides high diagnostic coverage, self-checking and advanced diagnostic features in full compliance with functional safety standards IEC 61508 and ISO 26262.
Safety qualification kit (Qkit)	Nios II fast, standard and economy cores	Validas AG	Enables software designers to qualify the use of Nios II Toolchain in their safety application, fulfilling the requirements of IEC 61508 up to SIL 4 and ISO 26262 up to ASIL D.

### Notes:

1. With the Nios II Gen2 product the standard core is not available as a pre-configured option, however the Gen2 fast core can be configured in the Platform Designer to have the same feature set as the standard core.
2. Starting with Nios II EDS v19.1, the Nios II EDS requires the Eclipse IDE component to be manually installed. Details on installing Eclipse IDE can be found in the [Nios II Software Developer Handbook](#).

## Getting Started

To learn more about Intel's portfolio of customizable processors and how you can get started, visit [intel.com/content/www/us/en/products/details/fpga/nios-processor.html](http://intel.com/content/www/us/en/products/details/fpga/nios-processor.html).

# Customizable Processor Portfolio Overview

Performance and Feature Set Summary of Key Processors Supported on Intel FPGAs

Category	Performance-optimized core	Cost-and Power-Sensitive Processors	Real-Time Processor	Applications Processors		
Features	Nios V/m Microcontroller	Nios II Economy	Nios II Fast	28 nm <sup>1</sup> Dual-Core Arm Cortex-A9	20 nm <sup>2</sup> Dual-Core Arm Cortex-A9	14 nm <sup>2</sup> Quad-Core Arm Cortex-A53
Maximum frequency (MHz) <sup>3</sup>	~ 566 MHz (Intel Agilex FPGA) <sup>4</sup>	400 (Stratix V)	330 (Stratix V)	925 MHz (Cyclone V SoC) 1.05 GHz (Arria V SoC)	1.5 GHz (Intel Arria 10 -1 speed grade)	1.5 GHz (Intel Stratix and Intel Agilex FPGAs)
Maximum performance (MIPS at MHz) Intel Agilex device series	268 (at 566 MHz)	–	–	–	–	–
Maximum performance (MIPS <sup>5</sup> at MHz) Intel Stratix series	167 (at 360 MHz)	52 (at 400 MHz)	363 (at 330 MHz)	–	–	–
Maximum performance (MIPS <sup>5</sup> at MHz) Intel Arria series	141 (at 305 MHz)	44 (at 340 MHz)	319 (at 290 MHz)	2,625 MIPS per core at 1.05 GHz	3,750 MIPS per core at 1.5 GHz	–
Maximum performance (MIPS <sup>5</sup> at MHz) Intel Cyclone series	–	30 (at 230 MHz)	187 (at 170 MHz)	2,313 MIPS per core at 925 MHz	–	–
Maximum performance efficiency (MIPS <sup>5</sup> per MHz)	0.464	0.13	1.1	2.5	2.5	2.3
16/32/64 bit instruction set support	32	32	32	16 and 32	16 and 32	16/32/64
Level 1 instruction cache	–	–	Configurable	32 KB	32 KB	32 KB
Level 1 data cache	–	–	Configurable	32 KB	32 KB	32 KB
Level 2 cache	–	–	–	512 KB	512 KB	1 MB
Memory management unit	–	–	Configurable	✓	✓	✓(+System MMU)
Floating-point unit	–	–	FPH <sup>6</sup>	Dual precision	Dual precision	Dual precision
Vectored interrupt controller	–	–	Optional	–	–	–
Tightly coupled memory	–	–	Configurable	–	–	–
Custom instruction interface	–	Up to 256	Up to 256	–	–	–
Equivalent ALMs	1,500	600	1,800 – 3,200	HPS	HPS	HPS

## Notes:

- 28 nm SoCs comprise Cyclone V SoCs and Arria V SoCs.
- 20 nm SoCs comprise Intel Arria 10 SoCs.
- Maximum performance measurements measured on Stratix V FPGAs.
- Nios V processor Fmax is based on the highest speed grade device.
- Dhrystone 2.1 benchmark. Note that performance will vary with system and software configuration.
- Floating-point hardware – Nios II processor custom instructions.

# Intel and Intel Partner Alliance IP Functions

For a complete list of IP functions from Intel and Intel Partner Alliance, please visit [intel.com/fpgaip](http://intel.com/fpgaip).

	Product Name	Vendor Name	Product Name	Vendor Name
DSP	<b>Arithmetic</b>		<b>Video and Image Processing (Continued)</b>	
	Floating Point Intel FPGA IP	Intel	JPEG Encoders	CAST, Inc.
	Floating Point Arithmetic Co-Processor	Digital Core Design	Ultra-fast, 4K-compatible, AVC/ H.264 Baseline Profile Encoder	CAST, Inc.
	Floating Point Arithmetic Unit	Digital Core Design	Low-Power AVC / H.264 Baseline Profile Encoder	CAST, Inc.
	<b>Error Detection/Correction</b>		H.265 Main Profile Video Decoder	CAST, Inc.
	POLAR Encoder / Decoder	Intel	<b>Hard/Soft Processors</b>	
	Reed-Solomon Encoder/Decoder II	Intel	Nios II Embedded Processors	Intel
	Viterbi Compiler, High-Speed Parallel Decoder	Intel	Arm Cortex-A9 MPCore Processor in Intel SoC	Intel
	Viterbi Compiler, Low-Speed/ Hybrid Serial Decoder	Intel	Arm Cortex-A53 MPCore Processor in Intel SoC	Intel
	Turbo Encoder/Decoder	Intel	<b>Communication</b>	
	High-Speed Reed Solomon Encoder/Decoder	Intel	Optical Transport Network (OTN) Framers/Deframers	Intel
	BCH Encoder/Decoder	Intel	SFI-5.1	Intel
	Low-Density Parity Check Encoder/Decoder	Intel	<b>Ethernet</b>	
	Zip-Accel-C: GZIP/ZLIB/Deflate Data Compression Core	CAST, Inc.	200G MACsec	Intel
	Zip-Accel-D: GUNZIP/ZLIP/Inflate Data Decompression Core	CAST, Inc.	200G Symmetric Cryptographic (AES)	Intel
	<b>Filters and Transforms</b>		Low-Latency 10 Gbps Ethernet Media Access Controller (MAC) with 1588	Intel
	Fast Fourier Transform (FFT)/ Inverse FFT (IFFT)	Intel	Triple-Speed Ethernet (10/100/1000 Mbps) MAC and PHY with 1588 Option	Intel
	Cascaded Integrator Comb (CIC) Compiler	Intel	1 / 2.5 / 5 / 10G Multi-Rate PHY and Backplane Options	Intel
	Finite Impulse Response (FIR) Compiler II	Intel	10G Base-X (XAUI) PHY	Intel
	SHA-1	CAST, Inc.	25G MAC and PHY with RS-FEC option	Intel
	SHA-256	CAST, Inc.	40G Ethernet MAC and PHY with 1588 and Backplane Options	Intel
	AES CODECs	CAST, Inc.	50G MAC and PHY	Intel
	<b>Modulation/Demodulation</b>		100G Ethernet MAC and PHY with 1588 and RS-FEC options	Intel
	Numerically Controlled Oscillator Compiler	Intel	1G/10Gb Ethernet PHY	Intel
	ATSC and Multi-Channel ATSC 8-VSB Modulators	Commsonic	High-Performance Gigabit Ethernet MAC	IFI
	DVB-T Modulator	Commsonic	<b>High Speed</b>	
	DVB-S2 Modulator	Commsonic	eCPRI	Intel
	<b>Video and Image Processing</b>		O-RAN	Intel
	Video and Image Processing Suite	Intel	JESD204B	Intel
	Stereo Vision IP Suite	Fujisoft Incorporated	JESD204C	Intel
	Infinivision	Gidel	Common Public Radio Interface (CPRI)	Intel
	HD JPEG 2000 Encoders/Decoders	IntoPIX	Interlaken	Intel
TICO Lightweight Video Compression	IntoPIX	Interlaken Look-Aside	Intel	
Multi-Channel JPEG 2000 Encoder and Decoder Cores	Silex Insight	SerialLite II/III/IV	Intel	
VC-2 High Quality Video Decoder	Silex Insight	SATA 1.0/SATA 2.0	Intelliprop, Inc.	
VC-2 High Quality Video Encoder	Silex Insight	RapidIO Gen3	Mobiveil	
		QDR Infiniband Target Channel Adapter	Polybus	



	Product Name	Vendor Name
Interface and Protocols (Continued)	<b>PCI Express / PCI</b>	
	PCI Express Hard-IP Controller 3.0, 2.0, 1.0 x1 x2 x4 x8 x16 Controller with SR-IOV on Intel Stratix 10 GX FPGA	Intel
	PCI Express Hard-IP Controller 4.0, 3.0, 2.0, 1.0 x16 x8, x4 x2 x1 Controller with SR-IOV on Intel Stratix 10 DX FPGA	Intel
	PCI Express Hard-IP Controller 5.0, 4.0, 3.0, 2.0, 1.0 x16 x8, x4 x2 x1 Controller with SR-IOV on Intel Agilex FPGA	Intel
	PCI Express Memory-mapped bridge/ DMA IP on Intel Stratix 10 GX, Intel Stratix 10 DX, and Intel Agilex FPGAs	Intel
	PCI Express 4.0, 3.0, 2.0, 1.0 Scalable Switch IP with 1 UP port and up to 32 DN ports for Intel Stratix 10 and Intel Agilex FPGAs	Intel
	Multichannel DMA IP for Intel Stratix 10 GX, Intel Stratix 10 DX, and Intel Agilex FPGAs	Intel
	Expresso 3.0 PCI Express Core (1.0 -4.0)	Rambus (Northwest Logic)
	XpressRICH3 PCI Express 1.0, 2.0, 3.0, and 4.0	PLDA
	<b>CXL</b>	
	XpressLINK-SOC Controller IP for CXL 3.0, 4.0, 5.0 Endpoint & Rootport for Intel Agilex FPGAs	PLDA
	<b>Serial</b>	
	Generic QUAD SPI Controller	Intel
	Avalon® I <sup>2</sup> C (Master)	Intel
	I <sup>2</sup> C Slave to Avalon-MM Master Bridge	Intel
	Serial Peripheral Interface (SPI)/Avalon Master Bridge	Intel
	UART	Intel
	JTAG UART	Intel
	16550 UART	Intel
	JTAG/Avalon Master Bridge	Intel
	CAN 2.0/FD	CAST, Inc.
	Local Interconnect Network (LIN) Controller	CAST, Inc.
	H16550S UART	CAST, Inc.
	MD5 Message-Digest	CAST, Inc.
	Smart Card Reader	CAST, Inc.
	DI2CM I <sup>2</sup> C Bus Interface-Master	Digital Core Design
	DI2CSB I <sup>2</sup> C Bus Interface-Slave	Digital Core Design
	D16550 UART with 16-Byte FIFO	Digital Core Design
	DSPI Serial Peripheral Interface Master/ Slave	Digital Core Design
	Secure Digital (SD)/MMC SPI	El Camino GmbH
	Secure Digital I/O (SDIO)/SD Memory/ Slave Controller	Eureka Technology, Inc.
	SDIO/SD Memory/ MMC Host Controller	Eureka Technology, Inc.
	Nios II Advanced CAN	IFI
I <sup>2</sup> C Master/Slave/PIO Controller	Microtronix, Inc.	
I <sup>2</sup> C Master and Slave	SLS	

	Product Name	Vendor Name
Interface and Protocols (Continued)	<b>Serial (CONTINUED)</b>	
	USB High-Speed Function Controller	SLS
	USB Full-/Low-Speed Function Controller	SLS
	Embedded USB 3.0 / 3.1 Gen 1 Host and Device Controllers	SLS
	USB 3.0 SuperSpeed Device Controller	SLS
	<b>Audio and Video</b>	
	Character LCD	Intel
	Pixel Converter (BGR0 to BGR)	Intel
	Video Sync Generator	Intel
	SD/HD/3G-HD Serial Digital Interface (SDI)	Intel
	DisplayPort 1.1 and 1.2	Intel
	HDMI 1.4 and 2.0	Intel
	Bitec HDMI 2.0a IP core	Bitec
	DisplayPort 1.3 IP Core	Bitec
HDCP IP Core	Bitec	
MIPI CSI-2 Controller Core	Rambus (Northwest Logic)	
MIPI DSI-2 Controller Core	Rambus (Northwest Logic)	
AC'97 Controller	SLS	
<b>DMA</b>		
DMA Controllers	Eureka Technology, Inc.	
Lancero Scatter-Gather DMA Engine for PCI Express	Microtronix, Inc.	
AXI DMA back-End Core	Rambus (Northwest Logic)	
Expresso DMA Bridge Core	Rambus (Northwest Logic)	
Express DMA Core	Rambus (Northwest Logic)	
<b>Flash</b>		
CompactFlash (True IDE)	Intel	
EPCS Serial Flash Controller	Intel	
Flash Memory	Intel	
NAND Flash Controller	Eureka Technology, Inc.	
Universal NVM Express Controller (UNEX)	Mobiveil, Inc.	
ONFI Controller	SLS	
Enhanced ClearNAND Controller	SLS	
<b>SDRAM</b>		
DDR/DDR2 and DDR3/DDR4 SDRAM Controllers	Intel	
LPDDR2 SDRAM Controller	Intel	
RLDRAM 2 Controller	Intel	
Streaming Multi-Port SDRAM Memory Controller	Microtronix, Inc.	
HyperDrive Multi-Port DDR2 Memory Controller	Microtronix, Inc.	
Avalon Multi-Port SDRAM Memory Controller	Microtronix, Inc.	
<b>SRAM</b>		
SSRAM (Cypress CY7C1380C)	Intel	
QDR II/II+/II+Xtreme/IV SRAM Controller	Intel	

Memories and Memory Controllers

# Design Store

[fpgacloud.intel.com/devstore](https://fpgacloud.intel.com/devstore)

The Design Store contains Intel and partner FPGA design examples to assist you in designing with Intel FPGAs and associated development tools. Design examples can be filtered by device family, development kit, Intel Quartus software versions, and IP for easy search. These design examples showcase a wide range of interface IP, core function IP, configuration, embedded, and end applications. New content is continuously added and updated for all product families.

[Check out the Design Store](#) now.

## Design Example Search

intel

[PRODUCTS](#)
[SUPPORT](#)
[SOLUTIONS](#)
[DEVELOPERS](#)
[PARTNERS](#)

USA (ENGLISH)
 

Search Intel.com

[Intel® FPGA Support Resources](#) / [FPGA Design Store](#)

FPGA Design Store

Search this collection

**438 Results**

[Follow this collection →](#)
[In My Collections →](#)
[View Collection Access Details →](#)

**Filter by**

---

**FPGA Device Family** ^

[CLEAR](#)

[Intel® MAX® \(172\)](#)

[Intel® Cyclone® \(122\)](#)

[Intel® Arria® \(83\)](#)

[Intel® Stratix® \(53\)](#)

[Intel® Agilex™ FPGAs and SoC FPGAs \(7\)](#)

---

**Intel Quartus Prime Version** ^

[CLEAR](#)

[Intel® Quartus® Prime Standard Edition \(369\)](#)

[Intel® Quartus® Prime Pro Edition \(69\)](#)

[EXPAND ALL](#) | [COLLAPSE ALL](#)

Newest v

This website contains Intel's confidential information, which may only be used and disclosed in accordance with the applicable non-disclosure agreement between you or your company and Intel

Title	ID	Date	Version	Bookmark	Dropdown
<b>New</b>					
Stratix 10 - JTAG Remote Debugging Over a PCIe Interface Design Example	733510	06/10/22	1.0		<span style="font-size: 0.8em;">v</span>
MAX 10 - IO Module Design Example on Intel MAX10 for OPC UA	714783	10/04/21	17.0std.2 Standard		<span style="font-size: 0.8em;">v</span>
MAX 10 - DC-DC Converter Design Example (AN959)	714606	09/23/21	17.0.2 Standard		<span style="font-size: 0.8em;">v</span>

# Intel FPGA and Partner Development Kits

[intel.com/devkits](https://intel.com/devkits)

Intel FPGA development kits provide a complete, high-quality design environment for engineers. These kits help simplify the design process and reduce time to market. Development kits include software, reference designs, cables, and programming hardware. Intel FPGA and partner development kits are listed below. For more details about these development kits or other older development kits that are available, check out our online development kits page at [intel.com/devkits](https://intel.com/devkits).

Product and Vendor Name	Description
<b>Intel Agilex 7 FPGA Kits</b>	
Intel Agilex 7 FPGA F-Series Development Kit <b>Intel</b>	This kit allows you to design and develop your Intel Agilex 7 FPGA F-Series design, and includes all hardware and software needed to take advantage of the performance and capabilities of the Intel Agilex 7 FPGA F-Series with E-Tile and P-Tile. This PCIe form factor board can be used to develop and test PCI Express 4.0 designs, and external memory subsystems consisting of DDR4 and QDR IV memories. The kit also includes two QSFPDD connectors supporting both optical and electrical interfaces.
Intel Agilex 7 FPGA I-Series Development Kit <b>Intel</b>	The Intel Agilex 7 FPGA I-Series development kit delivers a complete prototyping and reference platform for designs needing PCI Express 5.0 (32 GT/s), Compute Express Link (CXL) v1.1, or 400G Ethernet connectivity. The Intel Agilex 7 FPGA I-Series Transceiver SoC development kit delivers a complete design environment that includes both hardware and software for developing with Intel Agilex 7 FPGA I-Series that contain 4x F-Tiles and 6 x F -Tiles.
<b>Intel Stratix 10 FPGA Kits</b>	
Intel Stratix 10 GX FPGA Development Kit <b>Intel</b>	This kit provides a complete design environment including all hardware and software needed to take advantage of the performance and capabilities of the Intel Stratix 10 GX FPGA. This kit can be used to develop and test PCI Express 3.0 designs, memory subsystem consisting of DDR4, DDR3, QDR IV, and RLDRAM III memories, and develop modular and scalable designs using FPGA mezzanine card (FMC) connectors.
Intel Stratix 10 GX Transceiver Signal Integrity Development Kit <b>Intel</b>	This kit provides a complete design environment including all hardware and software needed to take advantage of the performance and capabilities of the Intel Stratix 10 GX FPGA. This kit can be used to evaluate transceiver channel performance, generate and verify pseudo-random binary sequence (PRBS), and dynamically change the channel's differential output voltage (VoD), pre-emphasis, and equalization settings.
Intel Stratix 10 SX SoC Development Kit <b>Intel</b>	The kit offers a quick and simple approach for developing custom Arm processor-based SoC designs. It offers memory options, such as HiLo DDR4 and DDR4 SODIMM. There are also two FMC+ low-pin-count connectors and two quad small form factor pluggable (QSFP) connectors for transceiver channel performance. More notably, the kit offers two HPS peripheral daughtercards to expand the capabilities.
Intel Stratix 10 TX Signal Integrity Development Kit <b>Intel</b>	This kit offers a complete design environment for developing on the Intel Stratix 10 TX FPGA. It can evaluate E-Tile transceiver channel performance up to 58 Gbps PAM4 and 30 Gbps NRZ. The board has different QSFP-DD, FMC+, MXP, and SMA connectors for networking applications. It can also be used for jitter analysis and to verify physical medium attachment (PMA) compliance for 10/25/50G/100G/200G/400G Ethernet and other major standards.
Intel Stratix 10 MX FPGA Development Kit <b>Intel</b>	This kit can be used to test and develop designs using the Intel Stratix 10 MX FPGA, which features High-Bandwidth Memory (HBM). PCIe 3.0 designs can be developed as the board contains a PCIe end point connector and a PCIe root port connector. The board also contains a DIMM socket and HiLO connector for expanded memory capability.
S10VG4 <b>BittWare Inc.</b>	This PCI Express card is based on the Intel Stratix 10 FPGA and is ideal for high-density data center applications. BittWare's Viper platform offers support for large FPGA loads, up to 32 GB of DDR4 SDRAM, and 4x100 Gbps Ethernet. The card is enabled for high-speed networking with four front panel QSFP+ cages, each supporting 40/100GbE or four 10/25GbE channels. Serial expansion is available through two UltraPort SlimSAS connectors. A 1GbE interface, a pulse-per-second (PPS) input, and a USB interface are available for debug and support. The board's flexible memory configuration includes four DIMM sites that support DDR4 SDRAM and QDR.
Nallatech 520 <b>Nallatech</b>	This is a PCI Express accelerator card based on the Intel Stratix 10 FPGA designed to address a range of compute-intensive and latency-critical applications including machine learning, gene sequencing, oil and gas, and real-time network analytics. This introduces the ground-breaking single precision floating-point performance of up to 10 TFLOPS per device.

Product and Vendor Name	Description
<b>Intel MAX 10 FPGA Kits</b>	
Intel MAX 10 FPGA Nios II Embedded Evaluation Kit (NEEK) <b>Terasic</b>	This kit is a full featured embedded evaluation kit based on the Intel MAX 10 device family. The kit delivers an integrated platform that includes hardware, design tools, IP, and reference designs for developing a wide range of applications. This kit allows developers to rapidly customize their processor and IP to suit their specific needs, rather than constraining their software around the fixed feature set of the processor. The kit features a capacitive LCD multimedia color touch panel, which natively supports multi-touch gestures. An eight megapixel digital image sensor, ambient light sensor, and three-axis accelerometer make up this rich feature set, along with a variety of interfaces connecting the kit to the outside for Internet of Things (IoT) applications across markets.
Intel MAX 10 FPGA Development Kit <b>Intel</b>	This kit offers a comprehensive general-purpose development platform for many markets and applications, such as industrial and automotive. This fully featured development kit includes a 10M50DAF484C6G device, DDR3 memory, 2X 1 GbE, high-speed mezzanine card (HSMC) connector, quad serial peripheral interface, 16 bit digital-to-analog converter (DAC), flash memory, and 2X Digilent Pmod Compatible headers.
Intel MAX 10 FPGA Evaluation Kit <b>Intel</b>	The 10M08 evaluation board provides a cost-effective entry point to Intel MAX 10 FPGA design. The card comes complete with an Arduino header socket, which lets you connect a wide variety of daughtercards. Other features include an Intel MAX 10 10M08SAE144C8G device, Arduino shield expansion, access to 80 I/O through-holes, and a prototyping area.
DECA Intel MAX 10 FPGA Evaluation Kit <b>Arrow</b>	DECA is a full-featured evaluation kit featuring a 10M50DAF484C6G device. The kit includes a BeagleBone-compatible header for further I/O expansion, a variety of sensors (gesture/humidity/ temperature/CMOS), MIPI CSI-2 camera interface, LEDs, push buttons, and an onboard Intel FPGA Download Cable II.
Mpression Odyssey Intel MAX 10 FPGA IoT Evaluation Kit <b>Macnica</b>	The Macnica Intel MAX 10 FPGA evaluation kit connects and controls your FPGA design via Bluetooth using the Mpression Odyssey Smartphone application. This kit also includes a 10M08U169C8G device, SDRAM, Arduino shield expansion capability, and Bluetooth SMART connectivity module.
<b>Stratix V FPGA Kits</b>	
Stratix V Advanced Systems Development Kit <b>Intel</b>	This kit is a complete systems design environment that includes both the hardware and software needed to begin architecture development and system design using Stratix V FPGAs. The PCI Express-based form factor utilizes a x16 edge connector, and includes high memory bandwidth to DDR3, QDR II+, and serial memory. Multiple high-speed protocols are accessible through FMC and HSMC connections. A one year license for the Intel Quartus Prime Software is available with this kit.
Stratix V GX FPGA Development Kit <b>Intel</b>	This kit provides a full-featured hardware development platform for prototyping and testing high-speed serial interfaces to a Stratix V GX FPGA. This kit includes the PCI Express x8 form factor, two HSMC connectors for expandability, and Ethernet, USB, and SDI interfaces. Memory includes one x72 DDR3 SDRAM, one RDRAM II x18 QDR II+ SRAM, and flash memory. This kit also includes two SMA connectors for a differential transceiver output. Several programmable oscillators are available and other user interfaces include three user push buttons, one 8-position DIP switch, 16 user LEDs, an LCD display, and power and temperature measurement circuitry.
Transceiver Signal Integrity Development Kit, Stratix V GX Edition <b>Intel</b>	This kit enables a thorough evaluation of transceiver signal integrity and device interoperability. Features include seven full-duplex transceiver channels with SMA connectors, two 14G backplane connectors (from Amphenol and Molex), four programmable clock oscillators, four user push buttons, one 8-position DIP switch, eight user LEDs, a 7-segment LCD display, power and temperature measurement circuitry, and Ethernet, an embedded Intel FPGA Download Cable, and JTAG interfaces.
Transceiver Signal Integrity Development Kit, Stratix V GT Edition <b>Intel</b>	The Stratix V GT Transceiver Signal Integrity Development Kit provides a platform for electrical compliance testing and interoperability analysis. The accessibility to multiple channels allows for real-world analysis as implemented in the system with transceiver channels available through SMA and popular backplane connectors. This development kit can be used for evaluation of transceiver link performance up to 25.7 Gbps, generation and checking pseudo-random binary sequence (PRBS) patterns via an easy-to-use GUI that does not require the Intel Quartus Prime Software, access advanced equalization to fine-tune link settings for optimal bit error ratio (BER), jitter analysis, and verifying physical media attachment (PMA) interoperability with Stratix V GT FPGAs for targeted protocols, such as CEI-25/28G, CEI-11G, PCI Express 3.0, 10GBASE-KR, 10 Gigabit Ethernet, XAUI, CEI-6G, Serial RapidIO, HD-SDI, and others. You can use the built-in high speed backplane connectors to evaluate custom backplane performance and evaluate link BER.
100G Development Kit, Stratix V GX Edition <b>Intel</b>	This kit enables a thorough evaluation of 100G designs. It supports 10G/40G line interfaces through optical modules, and applications requiring external memory interfaces through one x18 QDR II and six x32 DDR3 memory banks. With this kit, you can evaluate transceiver performance up to 12.5 Gbps, and verify PMA compliance to standards, such as 10G/40G/100G Ethernet, Interlaken, CEI-6G/11G, Serial RapidIO, PCI Express (1.0, 2.0, and 3.0), and other major standards. This kit can also validate interoperability between optical modules, such as SFP, SFP+, QSFP, and CFP.
DSP Development Kit, Stratix V Edition <b>Intel</b>	The DSP Development Kit, Stratix V Edition provides a complete design environment that includes all the hardware and software you need to begin developing DSP intensive FPGA designs immediately. The development kit is RoHS-compliant. You can use this development kit to develop and test PCI Express designs at data rates up to 3.0, develop and test memory subsystems for DDR3 SDRAM or QDR II SRAM memories, and use the HSMC connectors to interface to one of over 35 different HSMCs provided by Intel partners, supporting protocols such as Serial RapidIO, 10 Gbps Ethernet, SONET, CPRI, OBSAI, and others.

Product and Vendor Name	Description
<b>Intel Arria 10 FPGA Kits</b>	
Intel Arria 10 FPGA Development Kit <b>Intel</b>	This kit provides a complete design environment including hardware and software for prototyping and testing high-speed serial interfaces to an Intel Arria 10 GX FPGA. This kit includes the PCI Express x8 form factor, two FMC connectors for expandability, Ethernet, USB, and SDIs. The board includes one HiLo connector for plugging in DRAM and SRAM daughtercards. Supported daughtercard formats include DDR4 x72 SDRAM, DDR3 x72 SDRAM, RDRAM 3 x36, and QDR IV x36 SRAM. The board includes SMA connectors for transceiver output, clock output, and clock input. Several programmable oscillators are available and other user interfaces include user push buttons, dual in-line package (DIP) switches, bi-color user LEDs, an LCD display, power, and temperature measurement circuitry. This development kit comes with a one-year license for the Intel Quartus Prime Software.
Intel Arria 10 FPGA Signal Integrity Kit <b>Intel</b>	This kit enables a thorough evaluation of transceiver signal integrity and device interoperability. Features include six full-duplex transceiver channels with 2.4 mm SMA connectors, four full-duplex transceiver channels to Amphenol Xcede+ backplane connector, four full-duplex transceiver channels to C form factor pluggable (CFP2) optical interface, four full-duplex transceiver channel to QSFP+ optical interface, one transceiver channel to SFP+ optical interface, and ten full-duplex transceiver channels to Samtec BullsEye high-density connector. This board also includes several programmable clock oscillators, user push buttons, DIP switches, user LEDs, a 7-segment LCD display, power and temperature measurement circuitry, Ethernet, an embedded Intel FPGA Download Cable II, and JTAG interfaces. This development kit comes with a one-year license for the Intel Quartus Prime Software.
Intel Arria 10 SoC Development Kit <b>Intel</b>	This kit offers a quick and simple approach for developing custom Arm processor-based SoC designs. The Intel Arria 10 SoCs offers full software compatibility with previous generation SoCs, a broad ecosystem of Arm software and tools, and an enhanced FPGA and DSP hardware design flow. This kit includes an Intel Arria 10 10AS066N3F40I2SG SoC, PCI Express 3.0 protocol support, a dual FMC expansion headers, two 10/100/1000 SGMII Ethernet ports, one 10/100/1000 RGMII Ethernet port, two 10GbE small form factor pluggable (SFP) cages, two 1GB DDR4 HPS HiLo memory card, DDR4 SDRAM, NAND, quad SPI, SD/MICRO boot flash cards, character LCD, display port, and SDI port.
Attila Instant-Development Kit Intel Arria 10 FPGA FMC IDK <b>REFLEX</b>	This kit provides out-of-the-box experience, combining compact hardware platform and an efficient intuitive software environment. This kit is designed for high-performance serial transceiver applications using Intel Arria 10 GX 1150 KLEs. Hardware, software design tools, IP, and pre-verified reference designs included. Its unique installation and GUI allows an immediate start, and its reference designs enable fast turn-around designs, shortening and securing the developments.
Alaric Instant-Development Kit Intel Arria 10 SoC FMC IDK <b>REFLEX</b>	This kit provides out-of-the-box experience, combining compact hardware platform and an efficient intuitive software environment. This kit is designed for high-performance serial transceiver applications using an Intel Arria 10 SoC with 660 KLEs and an Arm dual-core Cortex-A9 MPCore. Its unique installation and GUI allows an immediate start, and its reference designs enable fast turn-around designs, shortening and securing the developments.
Nallatech 510T <b>Nallatech</b>	Nallatech 510T is an FPGA co-processor that is designed to deliver ultimate performance per watt for compute-intensive data center applications. The 510T is a GPU-sized 16-lane PCI Express 3.0 card featuring two of Intel's new floating-point enabled Intel Arria 10 FPGAs delivering up to 16 times the performance of the previous generation <sup>1</sup> . Applications can achieve a total sustained performance of up to 3 TFLOPS.
<b>Intel Cyclone 10 FPGA Kits</b>	
Intel Cyclone 10 LP Evaluation Kit <b>Intel</b>	This kit provides an easy-to-use platform for evaluating Intel Cyclone 10 LP FPGA technology and Intel Enpirion regulators. This evaluation board enables you to develop designs for Intel Cyclone 10 LP FPGAs via Arduino UNO R3 shields, Digilent Pmod Compatible cards, GPIOs, or Ethernet connector. This kit also measures key Intel Cyclone 10 LP FPGA power supplies and reuse the kit's PCB schematic as a model for your design.
Intel Cyclone 10 GX FPGA Development Kit <b>Intel</b>	This kit is an ideal starting point for developing applications, such as embedded vision, factory automation, and surveillance. With this development kit, you can develop Intel Cyclone 10 GX FPGA-based designs with expansion through PCIe 2.0, USB 3.1, SFP+, and RJ-45.

Product and Vendor Name	Description
<b>Arria V FPGA and SoC Kits</b>	
Arria V GX Starter Kit, Arria V GX Edition <b>Intel</b>	This kit provides a low-cost platform for developing transceiver I/O-based Arria V GX FPGA designs. This kit includes the PCI Express x8 form factor, one HSMC connector, a 32 bit DDR3 SDRAM device, one-channel high-speed transceiver input and output connected to SMAs, HDMI output, SDI input and output, 16x2 LCD display, and flash memory.
Arria V SoC Development Kit and SoC Embedded Design Suite <b>Intel</b>	The Arria V SoC Development Kit offers a quick and simple approach to develop custom Arm processor-based SoC designs. Intel's midrange, transceiver-based Arria V FPGA fabric provides the highest bandwidth with the lowest total power for midrange applications such as remote radio units, 10G/40G line cards, medical imaging, broadcast studio equipment, and the acceleration of image- and video-processing applications. This development kit includes the SoC Embedded Design Suite software development tools. The development board has PCI Express 2.0 x4 lanes (endpoint or rootport), two FMC expansion headers, dual Ethernet PHYs, and various DRAM and flash memories.
<b>Cyclone V FPGA and SoC Kits</b>	
Cyclone V E FPGA Development Kits <b>Intel</b>	The Cyclone V E Development Kit offers a comprehensive general-purpose development platform for many markets and applications, including industrial, networking, military, and medical applications. The kit features an Intel Cyclone V device and a multitude of onboard resources including multiple banks of DDR3 and LPDDR2 memory, LCD character display, LEDs, user switches, USB, and RJ-45 connectors. The Cyclone V E FPGA Development Kit gives industrial equipment designers greater flexibility in implementing real-time Ethernet communications with industrial Ethernet IP cores.
Cyclone V GT FPGA Development Kit <b>Intel</b>	This kit can be used to prototype Cyclone V GT FPGA or Cyclone V GX FPGA applications. It offers a quick and simple way to develop low-cost and low-power system-level designs and achieve rapid results. This kit supports a myriad of functionalities, such as FPGA prototyping, FPGA power measurement, transceiver I/O performance up to 5 Gbps, PCI Express 2.0 x4 (at 5 Gbps per lane), endpoint or rootport support.
Cyclone V SoC Development Kit <b>Intel</b>	The Cyclone V SoC Development Kit offers a quick and simple approach to develop custom Arm processor-based SoC designs accompanied by Intel's low-power, low-cost Cyclone V FPGA fabric. This kit supports a wide range of functions, such as processor and FPGA prototyping and power measurement, industrial networking protocols, motor control applications, acceleration of image- and video-processing applications, PCI Express x4 lane with ~1,000 MBps transfer rate (endpoint or rootport).
Cyclone V GX Starter Kit <b>Terasic Technologies</b>	The Cyclone V GX Starter Kit offers a robust hardware design platform based on Cyclone V GX FPGA. This kit is optimized for the lowest cost and power requirement for transceiver applications with industry-leading programmable logic for ultimate design flexibility. The Cyclone V Starter Kit development board includes hardware, such as Arduino Header, onboard Intel FPGA Download Cable circuit, audio and video capabilities, and an onboard HSMC connector with high-speed transceivers that allows for an even greater array of hardware setups.
DE0-Nano-SoC Kit <b>Terasic Technologies</b>	The DE0-Nano-SoC Kit combines a robust, Cyclone V SoC-based development board and interactive reference designs into a powerful development platform. This low-cost kit is an interactive, web-based guided tour that lets you quickly learn the basics of SoC development and provides an excellent platform on which to develop your own design. The board includes a Gigabit Ethernet port, USB 2.0 OTG port, SD card flash, 1 GB DDR3 SDRAM, an Arduino header, two 40-pin expansion headers, onboard Intel FPGA Download Cable circuit, 8-channel A/D converter, accelerometer, and much more.
<b>MAX V CPLD Kits</b>	
MAX V CPLD Development Kit <b>Intel</b>	This low-cost platform will help you quickly begin developing low-cost, low-power CPLD designs. Use this kit as a stand-alone board or combined with a wide variety of daughtercards that are available from third parties. With this platform, you can develop designs for the 5M570Z CPLD and build upon example designs provided.
<b>Stratix IV FPGA Kits</b>	
100G Development Kit, Stratix IV GT Edition <b>Intel</b>	This kit enables a thorough evaluation of 100G designs. It supports 10G/40G line interfaces through optical modules, and applications requiring external memory interfaces through four x18 QDR II and four x32 DDR3 memory banks. With this kit, you can evaluate transceiver performance up to 11.3 Gbps, verify PMA compliance to standards, such as 10G/40G/100G Ethernet, Interlaken, CEI-6G/11G, Serial RapidIO, PCI Express (1.0, 2.0, and 3.0), and other major standards. This kit can also validate interoperability between optical modules, such as SFP, SFP+, QSFP, and CFP.

Product and Vendor Name	Description
<b>Cyclone IV FPGA Kits</b>	
Cyclone IV GX FPGA Development Kit <b>Intel</b>	This kit provides a comprehensive design environment that allows you to quickly develop low-cost and low-power FPGA system-level designs. This kit includes the PCI Express short card form factor, two HSMC connectors, and a 10/100/1000 Mbps Ethernet interface. Onboard memory includes 128 MB DDR2 SDRAM, 64 MB flash, and 4 MB SSRAM. This kit also includes SMA connectors, and 50 MHz, 100 MHz, and 125 MHz clock oscillators, as well as user interfaces including push buttons, LEDs, and a 7-segment LCD display.
DEO-Nano Development Board <b>Terasic Technologies</b>	The DEO-Nano Development Board is a compact-sized FPGA development platform suited for prototyping circuit designs such as robots and "portable" projects. The board is designed to be used in the simplest possible implementation targeting the Cyclone IV device up to 22,320 LEs. This kit allows you to extend designs beyond the DEO-Nano board with two external general-purpose I/O (GPIO) headers and allows you to handle larger data storage and frame buffering with onboard memory devices including SDRAM and EEPROM. This kit is lightweight, reconfigurable, and suitable for mobile designs without excessive hardware. This kit provides enhanced user peripheral with LEDs and push buttons and three power scheme options including a USB Mini-AB port, 2-pin external power header, and two DC 5-V pins.
Industrial Networking Kit <b>Terasic Technologies</b>	The Industrial Networking Kit (INK) offers a comprehensive development platform for industrial automation and applications. The kit consists of the DE2-115 board featuring the Cyclone IV device and dual 10/100/1000-Mbps Ethernet, 128 MB SDRAM, 8 MB flash memory, 2 MB SRAM, HSMC and GPIO connectors, USB 2.0, an SD card slot, switches and buttons, LEDs, 16x2 display, audio and video, and VGA-out. The kit also includes an Industrial Communications Board (ICB-HSMC) that supports RS-485, RS-232, CAN, and additional I/O expansion.
DE2-115 Development and Education Board <b>Terasic Technologies</b>	This board is part of the DE2 educational development board series and features the Cyclone IV E EP4CE115 FPGA. The DE2-115 offers an optimal balance of low cost, low power, and a rich supply of logic, memory and DSP capabilities, as well as interfaces to support mainstream protocols including GbE. A HSMC connector is provided to support additional functionality and connectivity via HSMC daughtercards and cables.
<b>MAX II CPLD Kits</b>	
MAX II/MAX IIZ Development Kit <b>System Level Solutions</b>	This board provides a hardware platform for designing and developing simple and low-end systems based on MAX II or MAX IIZ devices. The board features a MAX II or MAX IIZ EPM240T100Cx or EPM240ZM100Cx device with 240 LEs and 8,192 bits of user flash memory (UFM). The board also supports vertical migration into EPM570T100Cx devices with 570 LEs and 8,192 bits of UFM.

# Intel FPGA-Based SoM Partner Ecosystem

[intel.com/fpgasoms](http://intel.com/fpgasoms)

System on modules (SoMs) provide a compact, pre-configured solution with FPGA, memory, and software which is perfect for prototyping, proof-of-concept, and initial system development and production. SoMs enable you to focus on development of your IP, algorithms, and human/mechanical interfaces rather than spending time on the fundamentals of the processor and electrical system and software bring-up. In many cases, SoMs can also make sense for full system production.

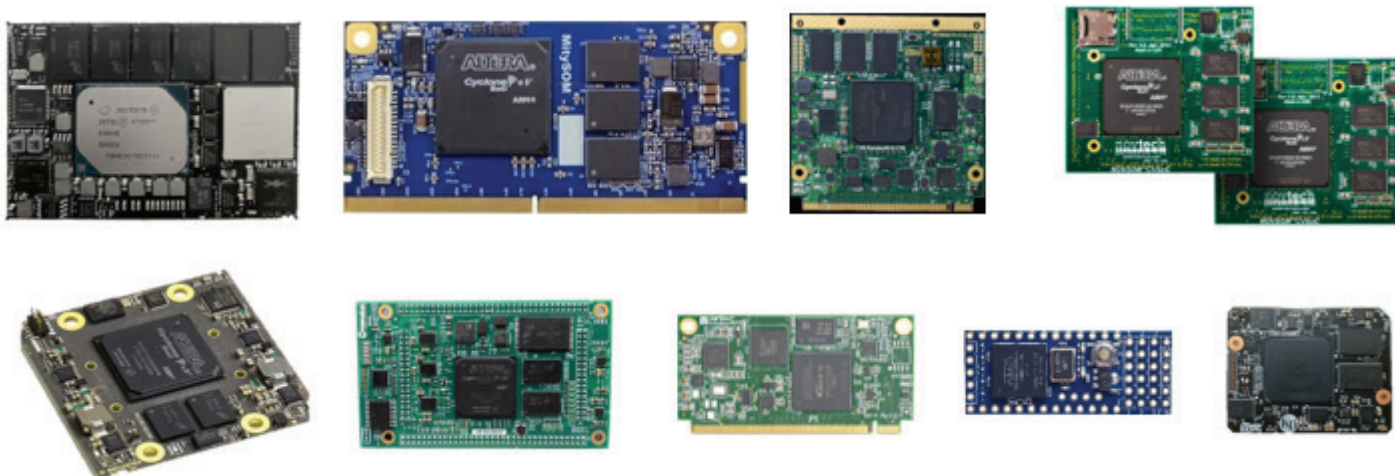

## Customer Benefits

- Faster time to market by off-loading complex board design
- Production-ready hardware for immediate deployment
- Versatile product design and application fit from various partners
- Minimize component supplier management

## Target Application

- General embedded applications
- Industrial PC, factory automation, and control applications
- Machine vision, surveillance camera, and retail applications
- Networking and security applications
- Test and measurement equipment

Partner	Partner Tier	SoM Product Name	Intel Device	Processor	FPGA Logic Elements	Target Application	Size (mm)
Exor International	Titanium	microSOM us02	Cyclone® V SoC (SE)	Dual-core Arm Cortex-A9 MPCore processor	25K/110K LEs	Industrial, 5G, AI	48x35
		GigaSOM gS01	Intel® Cyclone® 10 GX + Intel Atom® E39xx	Intel Atom x5-E3930 / x5-E3940 / x7-E3950	220K LEs		
Mantaro / HITEK systems	Titanium	Agilex HPC SOM	Intel® Agilex™	Quad-core 64-bit Arm Cortex-A53	1,437K LEs	HPC	174x138
		Agilex eSOM	Intel Agilex	Quad-core 64-bit Arm Cortex-A53	1,437K LE	Embedded Designs, Edge Appliances	120 x 120
Reflex CES	Titanium	COMXpress Stratix® 10 SoC	Intel® Stratix® 10 SX	Quad-core 64-bit Arm Cortex-A53	2,753K LEs	HPC, Video & Vision	125x95
		Achilles Arria® 10 SoM	Intel® Arria® 10 SoC	Dual-core Arm Cortex-A9 MPCore processor	270K/660K LEs	Industrial, Video & Vision, Radar Systems	85x95
Terasic	Titanium	Apollo Agilex SoM	Intel Agilex	Quad-core 64-bit Arm Cortex-A53	1,437K LEs	AI Edge, HPC	145x133
		Apollo S10 SoM	Intel Stratix 10 SX	Quad-core 64-bit Arm Cortex-A53	2,753K LEs	General purpose	151x185
		TSoM	Cyclone VSoC (SE)	Dual-core Arm Cortex-A9 MPCore processor	110K LE	General purpose	50 x 70



## Development Kits

Partner	Partner Tier	SoM Product Name	Intel Device	Processor	FPGA Logic Elements	Target Application	Size (mm)
Alorium Technology	Gold	Sno	Intel® MAX® 10		16K LEs	MCU replace	18x43
		Evo M51	Intel MAX 10	Atmel SAMD51 32-bit Arm Cortex-M4 processor	25K LEs	Motor Control	23x56
Critical Link	Gold	MitySOM-A10S	Intel Arria 10 SoC	Dual-core Arm Cortex-A9 MPCore processor	270K LEs	General purpose	82x39
		MitySOM-5CSX	Cyclone V SoC (SX)		Up to 110K LEs		
Enclustra	Gold	Mercury+ AA1	Intel Arria 10 SoC	Dual-core Arm Cortex-A9 MPCore processor	270K/480K LEs	Industrial	TBD
		Mercury SA1	Cyclone V SoC (SX)		110K LEs		56x54
		Mercury+ SA2	Cyclone V SoC (ST)		110K LEs		74x54
		Mars MA3	Cyclone V SoC (SX)		110K LE		68x30
		Mercury CA1	Cyclone® IV		75K/115K LEs		General purpose
GEB Enterprise	Gold	PICO SOM CARD MAX10	Intel MAX 10		Up to 50K LEs	Industrial	TBD
iWave System Technologies	Gold	iW-Rainbow-G24M	Intel Arria 10 SoC / GX	Dual-core Arm Cortex-A9 MPCore processor	660K LEs / 1150K LEs	ASIC prototyping, General Purpose	95x75
		iW-RainboW-G17M	Cyclone V SoC (SX)		Up to 110K LEs		70x70
Kondo Electronics	Gold	KEIm-08	Intel MAX 10		8K LEs	MCU replacement	70x35
		KEIm-25	Intel MAX 10		25K LEs	General purpose	
		KEIm-CVSoC	Cyclone V SoC (SX)	Dual-core Arm Cortex-A9 MPCore processor	85K LEs	Video & Vision, AI, Industrial	
MRA Digital	Gold	C5SOC-SOM-PROCESSOR	Cyclone V SoC (SX)	Dual-core Arm Cortex-A9 MPCore processor	110K LEs	Video & Vision, Industrial	66x56
		MAX 10-SOM-50	Intel MAX 10		50K LE	General purpose	64x66
NDR	Gold	N-EMB-100/110	Cyclone V SoC (SX)	Dual-core Arm Cortex-A9 MPCore processor	110K LEs	Industrial networking	TBD
		N-EMB-120	Intel MAX 10		50K LEs	Industrial networking	TBD
Novtech	Gold	NOVSOM CVL	Cyclone V SoC (SE)	Dual-core Arm Cortex-A9 MPCore processor	Up to 110K LEs	General purpose	68x35
		NOVSOM CV	Cyclone V SoC (SE, SX, ST)		Up to 110K LEs		73x64
Falcon Nano	Gold	MAX 10-System on Module 256 pin	Intel MAX 10		8K LE	Industrial IoT	81x81
Aries	Member	MAX	Intel Arria 10 SoC	Dual-core Arm Cortex-A9 MPCore processor	480K/660K LEs	General purpose	60x110
		MCXL	Intel Cyclone 10 LP		16K/40K/55K LEs		37x90
		MCV	Cyclone V SoC (SE, SX)	Dual-core Arm Cortex-A9 MPCore processor	25K/40K/85K/110K LEs		74x42
		MCVS (SMARC2.0)	Cyclone V SoC (SE, SX)	Dual-core Arm Cortex-A9 MPCore processor	25K/40K/85K/110K LE		82x50
		MX10	Intel MAX 10		4K/8K/16K/50KLE		70x35
		SpiderSOM	Intel MAX 10		2K/8K LEs		70x35
Macnica	Distributor	Borax SOM	Cyclone V SoC (SE)	Dual-core Arm Cortex-A9 MPCore processor	Up to 110K LEs	General purpose	95x55



# Intel Partner Alliance Program

[intel.com/partneralliance](https://intel.com/partneralliance)

The Intel® Partner Alliance is a program designed to enhance the value, relevance, and the experience we deliver to our partners. The unification of former Intel partner programs such as the Design Solutions Network and the FPGA Partner Program, to name a few, will allow Intel and its partners to continue driving the industry to innovate solutions with powerful technology. These investments will help enable disruption and accelerate new market opportunities in an increasingly data-centric world. From leading-edge technologies to sophisticated sales enablement and powerful partner networking, the Intel Partner Alliance will connect partners to a world of innovation.

[Join the Intel Partner Alliance](#)

Visit the Intel® Solutions Marketplace to connect with thousands of partners, opening the door to matchmaking opportunities to grow your business and innovate. Access the vast catalog of Intel Solutions Marketplace offerings and Partner Directory – the fastest way to find products, solutions, and Intel Partner Alliance partners that meet your business needs. The Intel Solutions Marketplace is a vast resource in which to network with industry providers and discover offerings to meet their business needs.

[Visit the Intel® Solutions Marketplace](#)

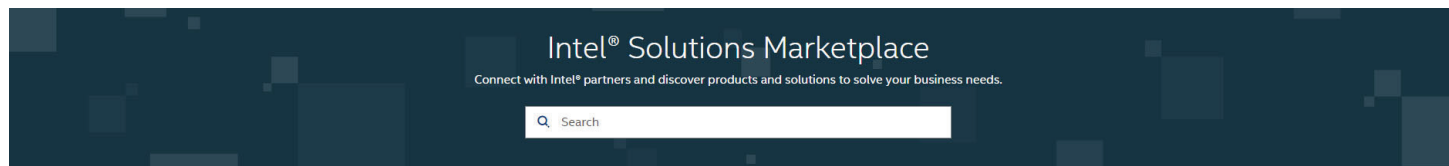

## Featured Offerings

[Intel® IoT Market Ready Solutions](#)   [Intel® IoT RFP Ready Kits](#)   [Intel® Select Solutions](#)

FEATURED	FEATURED	FEATURED	FEATURED
<p><b>Indra Active Grid Management (AGM) Suite</b></p> <p>Industrial IoT based real time monitoring &amp; control infrastructure. The distribution of electricity is undergoing a fundamental...</p> <p>by <b>INDRA SISTEMAS, S.A.</b> Solution Intel® IoT Market Ready Solutions</p> <p><input type="checkbox"/> Add To Compare</p> <p><a href="#">QUICK VIEW</a></p>	<p><b>Qualitas EagleEye® Platform</b></p> <p>Qualitas EagleEye® Platform (QEP) is a complete solution for developing highly accurate machine vision solutions with minimal integration effort...</p> <p>by <b>Qualitas Technologies Pvt Ltd</b> Solution Intel® IoT Market Ready Solutions</p> <p><input type="checkbox"/> Add To Compare</p> <p><a href="#">QUICK VIEW</a></p>	<p><b>Cisco Digital Utilities (Distribution Automation) – Smart Grid and Network Solutions Enable Security</b></p> <p>Cisco's Distribution Automation solutions integrate distribution grid control and protection solutions (devices and head-end...</p> <p>by <b>CISCO SYSTEMS</b> Solution Intel® IoT Market Ready Solutions</p> <p><input type="checkbox"/> Add To Compare</p> <p><a href="#">QUICK VIEW</a></p>	<p><b>V-Series VigitSIGN</b></p> <p>Cloud Digital Signage Solutions. It's specialized form of silver casting in which video or multimedia content is displayed in public place...</p> <p>by <b>V-series International Sdn Bhd.</b> Solution Intel® IoT Market Ready Solutions</p> <p><input type="checkbox"/> Add To Compare</p> <p><a href="#">QUICK VIEW</a></p>

■ □ □ □

[View all Intel® IoT Market Ready Solutions →](#)



### Intel® Network Builders

Deliver New 5G Core, vRAN, Edge Networking Solutions with Intel® Partners

Intel's partners who are recognized to be leaders in delivering end to end networking solutions, systems and services with customer and with partners are called Network Specialty partners.

Check here the list of commercially available, ready to deploy solutions that are networking solutions from network builders.

[Explore →](#)

# Training Overview

[intel.com/fpgatraining](https://intel.com/fpgatraining)

Intel FPGA technical training offers many ways to learn. Sharpen your FPGA design skills today! All public training is free to attend.

<a href="#">On-Demand Training</a>	<a href="#">Learn FPGA Design Topics from Expert Instructors, All for FREE!</a>	<a href="#">Quick Video</a>
<p>Pre-recorded presentations and demonstrations, generally 30 minutes long. Online classes are free and available at any time, from any computer with Internet access with non-restrictive firewall. You can find some of these online training courses on the <a href="#">Intel FPGA Technical Training YouTube Channel</a>.</p>	<p>Most classes are taught in a series of two half-day sessions. The virtual classroom allows you to attend at work or from home. During class, access to a remote lab environment is provided – which means no setup is required for you to attend.</p>	<p>These short how-to YouTube videos teach specific skills to help solve your issues. Check out the <a href="#">Intel FPGA Quick Videos page</a> or the <a href="#">Engineer to Engineer: How-To YouTube Channel</a>.</p>

## Training

### Instructor-Led and Virtual Classes

Course Category	General Description
High-Level Design	Become more productive by designing faster with C and C++ by using high-level design tools like the High-Level Synthesis Compiler and the Intel® FPGA Add-On for oneAPI Base Toolkit.
Design Languages	Attain the skills needed to design with Verilog HDL and VHDL for programmable logic.
Intel Quartus Prime Software	Acquire design entry, compilation, programming, verification, and optimization skills by learning how to use both basic and advanced features of the Intel Quartus Prime Software.
Design Optimization Techniques	Learn design techniques and Intel Quartus Prime Software features to improve design performance. Note: While the focus of this course is the Intel Stratix 10 device family, many of the techniques you will learn can be used to improve performance in other device architectures.
System Integration	Build hierarchical systems by integrating IP and custom logic.
Embedded System Design	Learn to design an Arm-based processor system in an Intel FPGA.
System Design	Solve DSP and video system design challenges using Intel technology.
Connectivity Design	Build high-speed, gigabit interfaces using embedded transceivers found in leading-edge FPGA families.

† Tests measure performance of components on a particular test, in specific systems. Differences in hardware, software, or configuration will affect actual performance. Consult other sources of information to evaluate performance as you consider your purchase. For more complete information about performance and benchmark results, visit [www.intel.com/benchmarks](http://www.intel.com/benchmarks).

© Intel Corporation. Intel, the Intel logo, the Intel Inside mark and logo, the Intel Experience What's Inside mark and logo, Altera, Arria, Cyclone, Enpirion, Intel Atom, Intel Core, Intel Xeon, MAX, Nios, Quartus, Stratix, and Agilex are trademarks of Intel Corporation or its subsidiaries in the U.S. and/or other countries. See Trademarks on [intel.com](http://intel.com) for full list of Intel trademarks. Other marks and brands may be claimed as the property of others.